



PORTABLE TEST & MEASUREMENT
INSTRUMENTS

Measure up



About the CHAUVIN ARNOUX GROUP

Founded in Paris, France in 1893, **CHAUVIN ARNOUX** has spent the centuries since then developing its expertise in the design, manufacture and marketing of measuring instruments for professionals.

From handheld instrumentation to fixed electrical equipment and energy performance systems, and from control of the entire thermal process chain to industrial metrology, the **CHAUVIN ARNOUX** Group's offering meets every customer requirement across all the sectors (self-employed electricians, industry, government bodies, etc.).

“ CHAUVIN ARNOUX is a major player in the measurement market in France and internationally. ”

Your partner:

- energy performance
- regulatory testing
- environmental measurements
- installation supervision and sizing.

A Few Figures

- 10 subsidiaries worldwide
- 1,000 employees
- 8 production sites
- 6 R&D departments worldwide
- 11% of revenues invested in R&D
- Turnover of 100 million euros



Made in France

The French family company Chauvin Arnoux designs and manufactures 80 % of its products in the R&D Centres and production sites owned by the Group. Its three sites in Normandy and its site at Meyzieu, near Lyon, manufacture printed circuit boards, mechanical parts and temperature sensors, while also handling the assembly of measuring instruments for all the Group's brands.



6 expert measurement companies in one Group



Portable instrumentation for measuring electrical and physical quantities



ENERGY
Electrical measuring instruments and supervision solutions for demanding industries and environments



PYROCONTROLE
Sensors and control solutions for industrial processes



MANUMESURE
Metrology and regulatory testing. Measurement services (noise, air, water)



INDATECH
Optical sensors for quality control in the laboratory and on in-line processes



SPECTRALYS
Measurement of agri-food product quality using fluorescence and Infrared processes

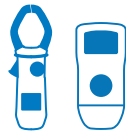

MULTIMETERS

- Clamp multimeters 4
- Multimeters 6



TESTERS

- LED voltage tester 10
- Digital testers 10



PHYSICAL MEASUREMENTS

- Contact thermometers 11
- Thermo-hygrometers 12
- Measurement of CO₂ / Temperature / Humidity 12
- Luxmeters 13
- Thermo-anemometers 13



ELECTROCHEMISTRY

- pH and temperature testers 14
- Conductivity meter 14
- Portable pH-meter 15



THERMOGRAPHY

- DiaCAm2 thermal cameras 14



TESTING AND ELECTRICAL SAFETY

- Digital insulation testers 18/22-25
- Electrical installation testers 18/20
- 2P & 3P earth/ground testers 19
- 3P & 4P earth/ground and resistivity testers 26
- Earth/ground and resistivity testers 26
- Earth and resistivity kit 26
- Earth/ground and resistivity testers with pylon earth measurement adapter 27
- Earth clamps 28
- Cable and metal duct detector 29
- Micro-ohmmeters 30
- Ratiometer 31



POWER, ENERGY, DISTURBANCES

- Three-phase network and power analysers 32
- Power and energy loggers 34



OSCILLOSCOPES

- Portable oscilloscopes 36



CURRENT MEASUREMENTS

- AC and AC/DC current measurements 38
- Measurements with oscilloscopes 39
- Ammeters with flexible sensors 40
- Flexible current sensors 41



DATA PROCESSING SOFTWARE

- DataView software 42



ACCESSORIES

- Measurement leads, protection and transport accessories 42



MULTIMETERS

Digital multimeter clamps

1000 V
CAT IV

IP
54

True
InRush



**3 series of clamps for 3 measurement ranges:
discover our range and choose your clamp!**

F200

600 A_{AC} / 900 A_{DC}
Clamping Ø 34 mm

F400

1,000 A_{AC} / 1,500 A_{DC}
Clamping Ø 48 mm

F600

2,000 A_{AC} / 3,000 A_{DC}
Clamping Ø 60 mm

Voltage up to 1,000 V + Resistance, audible continuity
+ True *InRush*

F201 / F401 / F601

AC applications

Everything you need
for installations
and equipment
powered by the
mains supply

F203 / F403 / F603

AC or DC applications

DC current
Temperature
Adapter function
ΔREL

F205 / F405 / F605

Mixed AC+DC applications + testing and maintenance

Power
THD
ΔREL
Min/Max/Peak
Phase rotation

F407 / F607

Mixed AC+DC applications + analysis and verification







Power
Harmonics
Ripple
Recording
PC software

True *InRush*
A CHAUVIN ARNOUX innovation

Thanks to the TrueInRush function, the clamp automatically determines the type of signal and the level of current in the installation and then adapts the algorithm and measurement procedure to capture the next current surge.

	F201	F203	F205	F401	F403	F405	F407	F603	F605	F607	
Reference	P01120921	P01120923	P01120925	P01120941	P01120943	P01120945	P01120947	P01120963	P01120965	P01120967	
Specifications											
Clamping diameter	Ø 34 mm			Ø 48 mm			Ø 60 mm				
Display	LCD		Backlit LCD		Backlit LCD		Backlit LCD				
Resolution	6,000 counts			10,000 counts			10,000 counts				
Number of values displayed	1			1			3		1		3
Type of acquisition	TRMS [AC]	TRMS [AC]/DC	TRMS [AC, AC+DC]/DC	TRMS [AC]	TRMS [AC]/DC	TRMS [AC, AC+DC]/DC		TRMS [AC]/DC	TRMS [AC, AC+DC]/DC		
Autorange function	Yes			Yes			Yes				
Automatic AC/DC detection	Yes			Yes			Yes				
AAC	0.15 to 600 A (900 A peak)			1 000 A			2,000 A (3,000 A peak)				
ADC	0.15 to 900 A peak			1,500 A peak			3,000 A				
AAC+DC	0.15 to 600 A (900 A peak)			1,000 A (1,500 A peak)			2,000 A (3,000 A peak)				
Best accuracy	1 % R + 3 counts			1 % R + 3 counts			1 % R + 3 counts				
VAC	0.15 to 1,000 A (1,400 A peak)			1,000 V			1,000 V				
VDC	0.15 to 1,400 V			1,400 V			1,400 V				
VAC+DC	0.15 to 1,000 V (1,400 V peak)			1,000 A (1,400 A peak)			1,000 A (1,400 A peak)				
Best accuracy	1% R + 3 cts			1 % R + 3 counts			1 % R + 3 counts				
Frequency of V / I	Yes / Yes										
Resistance	60 kΩ			100 kΩ			100 kΩ				
Audible continuity	Adjustable from 1 Ω to 599 Ω			Adjustable from 1 Ω to 999 Ω			Adjustable from 1 Ω to 999 Ω				
Diode test (semi-conductor junction)	Yes			Yes			Yes				
Adapter	Yes			Yes			Yes				
Single-phase and total three-phase power values	Yes			Yes			Yes				
temperature (K type)	°C: -60.0 to +1,000.0 °C / °F: -76.0 to +1,832 °F			°C: -60.0 to +1,000.0 °C / °F: -76.0 to +1,832 °F			°C: -60.0 to 1,000.0 °C / °F: -76.0 to +1,832 °F				
active (W)	Yes			Yes			Yes				
reactive Var (Q ₁)	Yes			Yes			Yes				
apparent (VA)	Yes			Yes			Yes				
PF / DPF	Yes / No			Yes / Yes			Yes / - Yes / Yes				
Harmonic analysis THD _v / THD _i	Yes / Yes			Yes / Yes			Yes / Yes				
Frequency analysis							25th order		25th order		
Phase rotation (2-wire method)	Yes			Yes			Yes				
Functions											
Overcurrent measurement	Yes			Yes			Yes				
Motor Inrush	Yes			Yes			Yes				
Load evolution (TrueInrush)	Yes			Yes			Yes				
Hold	Yes			Yes			Yes				
Min / MAX	Yes			Yes			Yes				
Peak+ / Peak-	Yes			Yes			Yes				
RELative ΔX	Yes			Yes			Yes				
Differential ΔX / X(%)	Yes			Yes			Yes				
Auto Power Off	Yes			Yes			Yes				
Data recording							Yes		Yes		
Communication interface							Bluetooth		Bluetooth		
Electrical safety according to IEC 61010	600V CAT IV			1,000 V CAT IV - 1,000 V CAT III			1,000 V CAT IV - 1,000 V CAT III				
Power supply	1 x 9 V LFP22			4 x 1.5 V AA			4 x 1.5 V AA				
Dimensions / Weight	78 x 222 x 42 mm / 340 g			92 x 272 x 41 mm / 600 g			111 x 296 x 41 mm / 640 g				
Warranty	3 years										

State at delivery

	F201 / F203	F401 / F403 / F601 / F603	F205 / F405 / F605	F407 / F607
 1 set of PVC cables (black/red) with built-in test probes Ø 4 mm isolated elbowed male banana plug	x1			
 1 set of PVC cables (black/red) Ø 4 mm isolated elbowed male banana plug Ø 4 mm isolated straight male banana plug		x1	x1	x1
 2 test probes (black/red) Ø 4 mm isolated female plug		x1	x1	x1
 1 black safety crocodile clip			x1	x2
 1 wire thermocouple with integrated Ø 4 mm isolated banana connections with 19 mm spacing	x1	x1		
 1 x 9 V 6LR61 battery (F200 series) 4 x 1.5V LR03 batteries (F400/F600 series)	x1	x1	x1	x1
 Multifix bag 120 x 245 x 60 mm (F200 series) 120 x 320 x 60 mm (F400/F600 series)	x1	x1	x1	x1



MULTIMETERS

TRMS AC/DC and AC/DC/AC+DC digital multimeters

The B-ASYC MTX 203 and MTX 204 offer high performance while remaining simple to use, even by inexperienced users.



600 V
CAT III
IP
54

	MTX 203	MTX 204
Reference	MTX203-Z	MTX204-Z
Display	6000 cts	6000 cts
Acquisition	TRMS AC/DC	TRMS AC/DC/AC+DC
Measurement rate	2 meas./second	
Autorange / Deactivatable		Yes / Yes
V_{DC}	Ranges 6 V / 60 V / 600 V	6 V / 60 V / 600 V
	Typical accuracy 0.2 % + 2 cts	0.2 % + 2 cts
	Resolution 0.01 V to 1 V	0.001 V
V_{AC}	Ranges 6 V / 60 V / 600 V / 750 V	0.6 to 750 V
	Resolution 0.001 V to 1V	0.5% + 4 cts
	Bandwidth 1 kHz	
V_{LOW AC} (low impedance + low-pass filter)	Ranges 6 V / 60 V / 600 V / 750 V	0.5% + 4 cts
	Resolution 0.001 V to 1 V	0.001 V
V_{AC + DC}	Ranges	
	Resolution 1%	1% + 4 cts
A_{DC}	Ranges 600 µA / 6 mA / 60 mA / 600 mA / 6 A / 10 A	600 µA / 60 mA / 6 A
	Resolution 0.1 µA to 0,01A	0.1 µA
A_{AC}	Ranges 600 µA / 6 mA / 60 mA / 600 mA / 6 A / 10 A	600 µA / 60 mA / 6 A
	Resolution 0.1 µA to 0.01A	0.1µA
A_{AC + DC}	Ranges	600 µA / 60 mA / 6 A
	Resolution 0.1µA	0.1µA
Resistance	Ranges 600 / 6 k / 60 k / 600 k / 6 M / 60 MW	
	Resolution 0.1 W to 0.01 MW	
Audible continuity	Yes	600 Ω
Frequency and duty cycle		2Hz to 1kHz
Diode test		Yes
Hz	Ranges No	2Hz to 1kHz
	Resolution 0.001 Hz	0.001 Hz
Capacitance	Ranges 1nF/10nF/100nF/10µF/100µF/1mF/10mF/100mF	
	Resolution 0.001 nF to 10 µF	
T°	Ranges -55°C to +1200°C	No
	Resolution 0.1 °C	No
Hold		Yes
Min / Max (100 ms)	No	Yes
Differential (DX) / Relative (DX/X%) measurement	No	Yes
Auto power-off		Yes (deactivatable)
Power supply		2 x 1.5 V AA
Dimensions / weight		170 x 80 x 50 mm / 320g

Useful : Backlit screen and torch



Practical : Magnetized shockproof sheath with compartment for stowing cables and 3-position stand



State at delivery

MTX 203 : 1 shockproof sheath, 2 x 1.5 m straight cables / test probe, 1 flexible K thermocouple with adapter Ø 4 mm, 1 user's manual on paper, 2 x 1.5 V AA batteries.

MTX 204 : 1 shockproof sheath, 2 x 1.5 m straight cables / test probe, 1 user's manual on paper, 2 x 1.5 V AA batteries.

Accessories

MULTIFIX accessory.....	P01102100Z
SHT40KV voltage probe.....	P01102097
Adapter + TK temperature sensor (MTX 203).....	P01102107Z
CMS clamp.....	HX0064
Set of 2 magnetized test probes.....	P01103058Z
Fuse F1000 V 10 A, 10 x 38 mm (x 5).....	P01297096
F1000 V 0.63 A, 6.3 x 32 mm (x 5).....	P01297098

ASYC IV digital multimeters range

IP
67



	MTX 3290	MTX 3291 *
Reference	MTX3290	MTX3291
DC, AC and AC+DC voltages (range)	60 mV to 600 V	60 mV to 1000 V
DC accuracy	0.3%	0.05%
AC and AC+DC bandwidth	20 kHz	100 kHz
DC, AC and AC+DC current (range)	600 µA to 10 A / 20 A (30 s max)*	
DC accuracy	1.2%	0.08%
Frequency (range)	60 Hz to 600 kHz	
Resistance (range)	600 Ω to 60 MΩ	
Audible continuity	600 W SIGNAL < 30 Ω ±5 Ω < 5 V	
Diode test	3 V with 1 mV resolution	
Capacitance (range)	6 nF to 60 mF	
Temperature Pt100/1000	-200 °C to 800 °C	
Temperature TK/TJ		
Other functions		
Monitoring	Time/date-stamped MAX/MIN / AVG or PEAK ±, on all the main positions	
REL	REL relative value + secondary display of measured reference value*	
PWM filter	300 Hz low-pass, 4th order for measurement on asynchronous motor variable speed drive	
Clamp voltage output function with direct reading	Integration of ratio 1/1, 1/10, 1/100, 1/1000 mV/A	
Secondary functions or measurements	dBm and resistive power in VA, duty cycle +/-, and pulse width*	
SPEC		
GRAPH		
Central zero	Selectable or automatic* bargraph for VDC and I DC	
Measurement storage		
General specifications		
Type of display	LCD with backlighting*, digit height 14 mm 60, 000-count* or 6, 000-count double display	
PC interfaces	Optical USB connector and SX-DMM software	
Power supply	4 AA batteries or Ni-MH rechargeable batteries	
Safety	Safety as per IEC61010-1 1000 V CAT III / 600 V CAT IV* or 600V CAT III / 300V CAT IV - Safety as per IEC 61010-2-033	
Environment	Storage -20 °C to +70 °C – Operation -10 °C to +55 °C	
Mechanical specifications	Dimensions (L x W x H): 196 x 90 x 47.1 mm – Weight: 570 g	
Warranty	3 years	

State at delivery

- **MTX 3290:** delivered with 4 x 1.5 V alkaline batteries, 1.5 m red straight/straight cable, 1.5 m black straight/straight cable, red CAT IV 1 kV test probe, black CAT IV 1 kV test probe, 1 user's manual on CD and 1 startup guide on paper
- **MTX 3291:** delivered with 4 x 1.5 V alkaline batteries, 1.5 m red straight/straight cable, 1.5 m black straight/straight cable, red CAT IV 1 kV test probe, black CAT IV 1 kV test probe, 1 user's manual on CD and 1 startup guide on paper, plus a bag, a USB cable, an SCPI remote programming manual and the SX-DMM software

Accessories

- Graphical colour MTX 329X calibration software > **HX0059B**
- Kit of 4 Ni-MH batteries > **HX0051B**
- MTX 328X and MTX 329X external charger (4 batteries included) . > **HX0053B**
- MTX DMM digital multimeter transport kit > **HX0052B**
- Graphical colour DMM transport kit > **HX0052C**
- MTX 3290 and MTX 3291 calibration software > **P01196770**





MULTIMETERS

TRMS AC, DC and AC+DC digital multimeters

Versatility for use in the field

**600 V
CAT IV**

**IP
54**



	CA 5273	CA 5275	CA 5277	
Reference	P01196773	P01196775	P01196777	
Display	2 x 6,000 counts, backlit			
Bargraph	61 + 2 elements, bi-mode (full scale / central zero)			
Acquisition	TRMS AC /DC	TRMS AC / DC / AC+DC		
Measurement rate	5 measurements / second			
Autorange / Deactivatable	Yes / Yes			
Automatic AC /DC detection	Yes	No		
V _{DC}	Ranges	600 mV / 6 V / 60 V / 600 V / 1,000 V		
	Typical accuracy	0.2 % + 2 cts	0.09 % + 2 cts	
	Resolution	0.1 mV to 1 V	0.01 mV to 1 V	
V _{AC}	Ranges	600 mV / 6 V / 60 V / 600 V / 1,000 V		
	Resolution	0.1 mV to 1 V	0.01 mV to 1 V	
	Bandwidth	40 Hz to 3 kHz	40 Hz to 10 kHz	
V _{Low AC} (Low impedance + Low-pass filter)	Ranges	600 mV / 6 V / 60 V / 600 V / 1,000 V		
	Resolution	0.1 mV to 1 V		
V _{AC + DC}	Ranges	60 mV / 600 mV / 6 V / 60 V / 600 V / 1,000 V		
	Resolution	0.01 mV to 1 V		
A _{DC}	Ranges	6 A / 10 A (20 A / 30 s)	6,000 µA / 60 mA / 600 mA / 6 A / 10 A (20 A / 30 s)	
	Resolution	0.001 A to 0.01 A	1 µA to 0.01 A ionization current; 0.2 µA to 20.0 µA	
A _{AC}	Ranges	6 A / 10 A	6,000 µA / 60 mA / 600 mA / 6 A / 10 A (20 A / 30 s)	
	Resolution	0.001 A to 0.01 A	1 µA to 0.01 A	
A _{AC + DC}	Ranges	6,000 µA / 60 mA / 600 mA / 6 A / 10 A (20 A / 30 s)		
	Resolution	1 µA to 0.01 A		
Resistance	Ranges	600 Ω / 6,000 Ω / 60 kΩ / 600 kΩ / 6 MΩ / 60 MΩ		
	Resolution	0.1 Ω to 0.1 MΩ		
Audible continuity	Yes			
Diode test	Yes			
Hz	Ranges	600 Hz / 6 kHz / 50 kHz		
	Resolution	0.1 Hz to 10 Hz		
Capacitance	Ranges	6 nF / 60 nF / 600 nF / 6 µF / 60 µF / 600 µF / 6 mF / 60 mF		
	Resolution	0.001 nF (1 pF) to 10 µF		
Temperature	Ranges	-59.6 °C to +1,200 °C -4 °F to +2,192 °F	-59.6 °C to +1,200 °C -4 °F to +2,192 °F	
	Resolution	0.1° to 1°	0.1° to 1°	
Hold	Yes			
Min / Max (100 ms)	Yes			
Peak+ / Peak- (1 ms)	No	Yes		
Differential measurement (ΔX) / Relative (ΔX/X%)	No	Yes		
Automatic power-off	Yes (deactivatable)			
Power supply	1 x 9 V			
Dimensions / weight	90 x 190 x 45 / 400 g			

State at delivery

CA 5270 multimeter delivered with a set of banana leads, a set of test probes, a 9 V battery and a CD containing the user's manual and the startup guide.

CA 5273 : plus a K temperature sensor

CA 5275 : plus a bag and a Multifix adapter

CA 5277 : plus a K thermocouple temperature sensor, a bag and a Multifix adapter

Accessories

MULTIFIX accessory.....	P01102100Z
SHT40KV voltage probe.....	P01102097
Adapter + TK temperature probe	P01102107Z
CMS clamp	HX0064
Set of 2 magnetized test probes	P01103058Z
Fuse F1000 V 10 A, 10 x 38 mm (x 5).....	P01297096
F1000 V 0.63 A, 6.3 x 32 mm (x 5)	P01297098

Digital multimeters



NEW PRODUCTS



	CA 5292	CA 5292BT	CA 5293	CA 5293BT
Standard reference	P01196802		P01196813	
Reference with Bluetooth communication		P01196812 Bluetooth		P01196813 Bluetooth
DC, AC and AC+DC voltages (range)	100 mV to 1,000 V			
DC accuracy	0.03 %		0.02 %	
AC and AC+DC bandwidth	100 kHz		200 kHz	
DC, AC and AC+DC current (range)	1000 µA to 10 A / 20 A (30 s max)			
DC accuracy	0.01 %			
Frequency (range)	10 Hz to 5 MHz			
Resistance (range)	100 Ω to 100 MΩ			
Audible continuity	1,000 Ω SIGNAL < 20 Ω < 3.5 V			
Diode test	Diode 0 -2.6 V < 1 mA + Zener diode or LED 0-20 V < 11 mA			
Capacitance (range)	1 nF to 10 mF			
Temperature Pt100/1000	-200°C to 800°C			
Temperature TK/TJ	-40 to +1,200°C			
Other functions				
Monitoring	Time/date-stamped SURV MAX / MIN / AVG or PEAK ± on all the main positions			
REL	REF-delta unit relative value or on 3 displays + main measurement			
PWM filter	300 Hz low-pass, 4th order for measurement on asynchronous motor variable speed drive			
Clamp voltage output function with direct reading	Settable ratio Ax			
Secondary functions or measurements	3 measurements + main measurement			
SPEC	Display of measurement tolerance +Smin+Smax			
GRAPH	Trend of main measurement < 60 s + Zoom + Cursor			
Central zero	Automatic trend bargraph			
Measurement storage	1,000		6,500	
General specifications				
Type of display	Graphical colour display (70 x 52) with backlighting, 4 x 100,000-count displays with black background			
PC interfaces	Optical USB connector or Bluetooth (option) – SX-DMM software			
Power supply	Charger or 4 AA batteries or Ni-MH rechargeable batteries			
Safety	Safety as per IEC61010-1 1000 V CAT III / 600 V CAT IV Safety as per IEC 61010-2-033			
Environment	Storage -20 °C to +70 °C – Operation 0 °C to +40 °C			
Mechanical specifications	Dimensions (L x W x H): 196 x 90 x 47.1 mm – Weight: 570 g			
Warranty	3 years			

Accessories

- Graphical colour MTX 329X calibration software > **HX0059B**
- Kit of 4 Ni-MH batteries > **HX0051B**
- MTX 328X and MTX 329X external charger (4 batteries included) . > **HX0053B**
- MTX DMM digital multimeter transport kit > **HX0052B**
- Graphical colour DMM transport kit > **HX0052C**

State at delivery

• **CA 5292, CA 5292BT and CA 5293, CA 5293BT:** delivered with a bag, 4 x NiMH 2400mAh 1.5V rechargeable batteries, 1 charger, 1 red 1.5m straight/straight cable, 1 black straight/straight cable, 1 red CAT IV 1 kV test probe, 1 black CAT IV 1kV test probe, 1 USB optical cable + SX-DMM software, 1 user's manual on CD, 1 SCPI programming commands manual and 1 start-up guide on paper





TESTERS

Voltage Absence Tester (VAT)

1000 V
CAT IV

IP
65



CA 773	
Reference	P01191773
Display	LEDs + Backlit digital display
Voltage detection	
Voltage	1.0 V to 299.0 VAC/DC 300 V to 1,000 VAC / 1,400 VDC
Frequency	DC, 162/3 to 800 Hz
Impedance	> 500 kΩ
Max. peak current	3.5 mA RMS
Polarity indication	Yes
Redundant hazardous voltage indication	The ELV (Extra Low Voltage) LED indicates a voltage higher than the SELV (Safety Extra-Low Voltage) and its flashing speed is proportional to the voltage
Stray voltage detection	Yes (by low-impedance load switching)
RCD tripping	Yes (by low-impedance load switching) (30 mA approx. at 230 V)
Phase/Neutral identification	Above 50 V (45 - 65 Hz) Above 150 V (162/3 - 45 Hz)
Continuity & Resistance	
Buzzer trigger threshold	100 Ω typical (150 Ω max.)
Extended continuity test (Resistance)	0.5 Ω to 2.999 kΩ
Test current / Open-circuit voltage	≤ 1 mA / ≤ 3.3 V
Phase rotation	2-wire method with microprocessor
Ph/Ph voltage	50 V ≤ U ≤ 1,000 Vac (45 - 400 Hz)
Buzzer	Intermittent beep for voltage detection Continuous beep for continuity
Standards and electrical safety	IEC 61243-3:2009, EN 61243-3:2010, IEC 61010 1000 V CAT IV
Enclosure protection	IP65
Climatic conditions	-15 °C to +45 °C (Class N)
Battery life	> 2,500 x10 s measurements
Dimensions / weight	228 x 60 x 39 mm (without test probe) 350 g approx.

State at delivery

- CA 773 delivered with 1 User's Manual in 5 languages, 2 x 1.5 V LR06/AA batteries, 1 set of removable test probes Ø 2 mm with crystal safety cap, 1 probe protector, 1 Velcro strap.

Accessories & replacement parts for CA 773:

CAT IV test probes for VAT	P01102123Z
Ø 2 mm test probes for VAT	P01102124Z
Ø 4 mm test probes for VAT	P01102125Z
Probe protector for VAT	P01102126Z
IP2X CAT IV test probes for VAT	P01102127Z
IP2X Ø 4 mm test probes for VAT	P01102128Z
MultiFix bag, 120 x 320 x 60 mm.....	P01298076

Digital testers

600 V
CAT III

IP
54



CA 757	
Reference	P01191757
Current testing	
Measurement range via current sensor	500 mA to 300 A (2 ranges)
Resolution	0.01 A to 0.1 A
DC voltage	
Measurement range	3 mV to 1,000 V – 4 ranges
Resolution	1 mV to 1 V
AC voltage	
Measurement range	100 mV to 1,000 V – 4 ranges
Resolution	1 mV to 1 V
Operating frequency	DC and 50/60 Hz
Impedance	10 MΩ
Non-contact voltage detection	230 V 50/60 Hz at a distance of approx. 5 cm
Audible continuity test	R ≤ 30 Ω
Resistance testing	
Measurement range	0.3 Ω to 30 MΩ – 6 ranges
Resolution	0.1 Ω to 0.01 MΩ
Capacitance testing	
Measurement range	400 pF to 30 mF
Resolution	0.001 nF to 0.01 mF
Standards	600 V CAT III, IEC 61010-1, IEC 61010-031, IEC 61010-032, IEC 61010-033
Power supply	2 x 1.5 V LR03 batteries
Battery life	100 hours with alkaline batteries – Automatic standby mode after 10 minutes
Dimensions / weight	180 x 52 x 45 mm / 200 g

State at delivery

- CA 757 delivered with 1 set of CAT III / IV fine-tipped test probes (red/black), 2 x 1.5 V LR03 alkaline batteries, 1 MiniFlex® sensor (loop length 250 mm), 1 Velcro strap

Replacement parts for CA 757

CAT III/IV red/black test probes.....	P01102152Z
Ø 2 mm CAT II red/black test probes.....	P01102153Z
Ø 4 mm CAT II red/black test probes.....	P01102154Z
Velcro strap x 5.....	P01102113
1.5 V LR3/AAA alkaline battery(x 1).....	P01296032
Bag compatible with MultiFix accessories, 120 x 200 x 60.....	P01298074
MultiFix mounting accessory	P01102100Z
MA101-250 current sensor for CA 757	P01120591



PHYSICAL MEASUREMENTS

Logger contact thermometers

- > J, K, T, N, E, R and S thermocouples (CA 1821 & CA 1822)
- > Pt100 and Pt1000 resistive probes (CA 1823)
- > Compact and magnetized for fixed or portable use
- > Can record up to 1 million points



	CA 1821 P01654821	CA 1822 P01654822	CA 1823 P01654823
Reference			
Sensor	J, K, T, N, E, R, S		Pt 100, Pt 1000
No. of inputs	1	2	1
Range	-250 °C to 1,767 °C		-100 °C to 400 °C
Resolution	$\theta < 1,000 \text{ °C}$: 0.1 °C and $\theta \geq 1,000 \text{ °C}$: 1 °C		0.1 °C
Accuracy	$\pm (0.1 \% R + 0.6 \text{ °C})$		$\pm (0.4 \% R + 0.3 \text{ °C})$
Functions	Min., Max., HOLD, Alarms		
Recording	Manual start and stop on the product - Programmed recording		
Alarms	Visual alert if the threshold definable via Data Logger Transfer is overrun Recording can be triggered on the alarm threshold		
Battery life	1,000 hrs (portable mode) or 800 hrs (for the CA 1823) / 3 years when recording (measurement base: 15 minutes)		
Protection	IP54		
Mounting	Casing equipped with a magnet, a wall-mount system and a slot for suspending the product. Compatible with the Multifix accessory.		
Connections	CA 1821 and CA 1822: compensated miniature female - CA 1823: 3-point flat connector		
Dimensions / weight	150 x 72 x 32 mm / 260 g with batteries		

State at delivery

Products delivered with carrying bag, batteries, 1 USB cable, 1 measurement report and quick startup guide (complete user's manual and Data Logger Transfer software available from the Chauvin Arnoux website)



Accessories and replacement parts

Handle for CK extension.....	P03652912
Connector for K thermocouple	P03652925
Temperature sensors for CA 1800	see page 34
Shockproof sheath + Multifix	P01654252
Multifix	P01102100Z
Mains adapter	P01651023
Carrying bag.....	P01298075
Metal case.....	P01298071
Dataview software	P01102095
BLE / USB Bluetooth modem for PC	P01654253
4 x NiMH AA/LR6 batteries + Charger	HX0053

Data Logger Transfer, the software for analysing your data

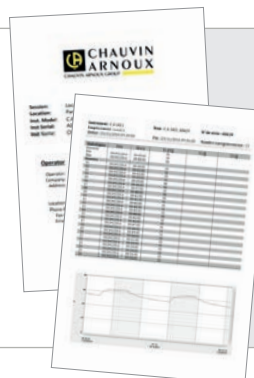

> Automatic report generation



Exportable in Word format

This simplifies editing and archiving.



PHYSICAL MEASUREMENTS

Thermo-hygrometers

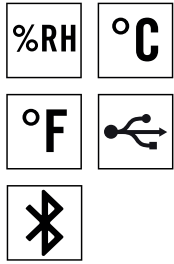

CA 1246	
Reference	P01654246
Relative Humidity range	3.0 to 98.0 %RH
Relative Humidity accuracy	10 to 90 %RH: ± (2 %RH ± 1 ct) outside that range: ± (4 %RH ± 1 ct)
Temperature range	- 10.0 to +60.0°C
Temperature accuracy	10 to 40°C: ± (0.5°C ± 1 ct) outside that range: ± (0.032 x (T-25) ± 1 ct) / T= temperature in °C
Dew point range and accuracy	Dew point: - 20.0 to +60.0 °Ctd Accuracy: 1.5°C
Functions	Min., Max., HOLD, Alarms
Recording	Manual start/stop on the product Programmed recording
Alarms	Visual alert when threshold definable via Data Logger Transfer is overrun Recording can be triggered on the alarm threshold
Battery life	1,000 hrs (portable mode) / 3 years when recording (measurements every 15 minutes)
Ingress protection	IP54
Mounting	Casing equipped with a magnet, a wall-mount system and a slot for suspending the product. Compatible with the Multifix accessory.
Dimensions / weight	187 x 72 x 32 mm / 260 g

State at delivery

CA 1246, delivered with carrying bag, batteries, USB cable, measurement report and quick startup guide (complete manual and Data Logger Transfer software available from the Chauvin Arnoux website)



Accessories and replacement parts



75%RH salt cartridge	P01156401
33%RH salt cartridge	P01156402
Shockproof sheath + Multifix	P01654252
Multifix	P01102100Z
Mains adapter	P01651023
Carrying bag	P01298075
Metal case	P01298071
Dataview software	P01102095
Bluetooth BLE / USB modem for PC	P01654253
4 x NIMH AA/LR6 batteries + Charger	HX0053

CO₂, Temperature and Humidity Logger



	CO ₂	Temperature	Humidity
Measurement range	0 to 5,000 ppm	-10°C to +60°C	5 to 95% RH
Accuracy	± 50 ppm ±3% R	±0.5°C	± 2% RH
Resolution	1 ppm	0.1°C	0.1% RH



	CA 1510	CA 1510 black
Reference	P01651011	P01651010
Recording intervals	Customizable from 1 minute to 2 hours	
Storage	More than 1 million points	
Buzzer and units	Yes / °C or °F	
Backlighting / Hold / Min Max	Yes	
Dimensions / Weight	125 x 65.5 x 32 mm / 190 g with batteries	
Power supply	Batteries: 2 x 1.5V LR6 or rechargeable battery Mains connection possible with mains adapter/ micro USB supplied as standard	
Interfaces	2 possible communication modes: Bluetooth wireless link and USB link. The product is then recognized as a USB key for simple file transfers	
Mounting	CA 1510 casing equipped with a magnet, a wall-mount system and a slot for suspending the product. A wall-mount with anti-theft protection (padlock not supplied) is available as an accessory. A desktop stand is also available (supplied as standard with the CA 1510W)	

State at delivery

White CA 1510 delivered in a cardboard box with batteries, 1 USB mains adapter, 1 USB-micro USB cable, desktop stand, quick startup guide, 1 CD-ROM containing the user's manual and data processing software.

Black CA 1510 delivered in a case with batteries, USB mains adapter, 1 USB cable, quick startup guide, 1 CD-ROM containing the user's manual and data processing software.

Accessories and replacement parts

Black wall-mount	P01651024
------------------------	-----------



Wall-mount



Calibration kit delivered with calibration software

Thermo-anemometers

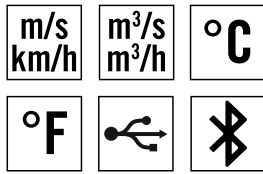

	CA 1227
Reference	P01654227
Air speed/flow-rate sensor	Vane with optical detection
Air speed range	0.25 m/s to 35.0 m/s (49.0 to 6890.0 fpm)
Air speed accuracy	± 3 % of reading ± 4 cts
Air flow-rate range	0 to 2,999 m³/h
Air flow-rate accuracy	± 8 % of reading
Temp. range °C/°F	- 20 to +50 °C / -4 to +122 °F
Temp. accuracy °C	0 to 50 °C: ± 0.8 °C -20 to 0 °C: ± 1.6 °C
Functions	Min., Max., HOLD, Average
Recording	Manual start and stop on the product Programmed recording
Data storage	More than 1 million points
Power supply	- 3 x 1.5V LR6 alkaline batteries or NiMH rechargeable battery - Mains connection via the mains / micro USB adapter (option)
Battery life	200 hrs (portable mode) / 8 days for recording (15-minute measurement interval)
Dimensions	Casing: 150 x 72 x 32 mm Sensor: 160 x 80 x 38 mm Spiral cable: 24 to 120 cm
Weight	Approx. 400 g
Ingress protection	IP40 casing
Operating temperature / humidity	-10 to +60 °C - 10 to 90 % RH
Standards	IEC 61010-1 - IEC 61326-1

State at delivery



CA 1227 delivered with carrying bag, 3 x 1.5V AA alkaline batteries, USB cable, measurement report and quick startup guide (complete manual and Data Logger Transfer software available from the Chauvin Arnoux website)

Luxmeters

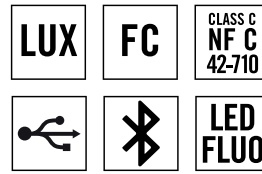

	CA 1110
Reference	P01654110
Measurement range	0.1 to 200,000 lx 0.01 to 18,580 fc
Accuracy in standard mode	
Incandescent lamp	± 3 % of reading
LED	± 6 % of reading (3,000 K and 6,000 K)
Fluorescent lamps	± 9 % of the reading
Accuracy in compensation mode	
LED mode	± 4 % of the reading (at 4,000 K)
Fluo mode	± 4 % of the reading (type F11, 4,000 K)
Functions	Min., Max., HOLD, Average
Recording	Manual start and stop on the product Programmed recording
MAP mode	The MAP function can be used to map the lighting on a surface or in a room. The illuminance measurements are thus stored in the same file.
Data storage	More than 1 million points
Power supply	- 3 x 1.5V LR6 batteries or NiMH rechargeable battery - Mains connection via the mains / micro USB adapter (option)
Battery life	500 hrs (portable mode) / 3 years for recording (15-minute measurement interval)
Dimensions	Casing: 150 x 72 x 32 mm Sensor: 67 x 64 x 35 mm (with protective cover) Spiral cable: 24 to 120 cm
Weight	345 g with batteries
Ingress protection	IP50 casing
Operating temperature / humidity	-10 to +60 °C - 10 to 90 % RH
Standards	Class C according to the NF C 42-710 standard

State at delivery

CA 1110 delivered with carrying bag, 3 x 1.5V AA alkaline batteries, USB cable, measurement report and quick startup guide (complete manual and Data Logger Transfer software available on the Chauvin Arnoux website).



Accessories and replacement parts for the CA 1227 & CA 1110

Cones kit for vane flow-rate measurement for CA 1227 (circular cross section Ø 210 mm and rectangular cross section 346 x 346 mm)P01654250
Ø 80 mm vane sensor for CA 1227.....P01654251
Shockproof sheath + Multifix.....P01654252
Multifix.....P01102100Z

Mains adapterP01651023
Carrying bag.....P01298075
Metal case.....P01298071
Dataview software.....P01102095
Bluetooth BLE / USB modem for PCP01654253
4 x NiMH AA/LR6 batteries + ChargerHX0053



CA 10001 watertight pH/temperature tester

IP 65
pH
Redox
°C
°F

	pH	Temperature
Reference	P01710015	
Measurement range	0.00 – 14.00 pH	0,0 – 60,0 °C 32,0 – 140,0 °F
Resolution	0.01 pH	0.1 °C / 0.1 °F
Error	± 0.1 pH	± 1 °C / ± 2 °F
Calibration	Automatic; 1, 2 or 3 points ; stored buffers	
Interchangeable electrode	No	
Power supply /Life span	2 x CR2032 3V batteries / >100 hours	
Auto power-off	After 20 min without activity	
Dimensions/weight	227 x 36 x 20 mm / 65 g	
Environment	Operating range / 0 to +50°C, max. Relative Humidity 80% Storage range -10 to +50°C, max. Relative Humidity 90%	
Warranty	1 year	

- > Automatic, extremely easy calibration at 3 points: saves time!
- > Detection of temperature-compensated pH values (ATC)

State at delivery

Two CR2032 3V batteries, one electrode storage flask, one multilingual User's Manual, one verification certificate.

Accessories

pH 4.01 buffer solution (NIST)*, 125 mL.....	P01700106
pH 7.00 buffer solution (NIST)*, 125 mL.....	P01700107
pH 10.01 buffer solution (NIST)*, 125 mL.....	P01700109
Set of 3 plastic beakers.....	P01710056

* Delivered with a quality certificate guaranteeing compliance with the NIST (National Institute of Standards and Technology) and DIN 19266 standards.



CA 10141 conductivity meter

Measurement parameters:
conductivity, TDS
(Total Dissolved Solids),
resistivity, salinity,
temperature (°C or °F)

IP 67
Conductivity
TDS
Resistivity

Salinity
°C
°F



	CA 10141
Reference	P01710020
Measurement range (instr. alone)	0,050 µS/cm to 500,0 mS/cm
Resolution (R)	0.001 to 0.1 (depending on range)
Intrinsic uncertainty (instr. alone)	± 0.5% ± R
TDS	
Measurement range (instr. alone)	0.001 mg/l to 499,9 g/l
Resolution (R)	0.001 to 0.1 (depending on range)
Intrinsic uncertainty (instr. alone)	± 0.5% ± R
Resistivity	
Measurement range (instr. alone)	2.000 Ω.cm to 19.99 MΩ.cm
Resolution (R)	0.001 to 0.01 (depending on range)
Intrinsic uncertainty (instr. alone)	± 0.5% ± R
Salinity	
Measurement range (instr. alone)	2.0 to 42.0 psu
Resolution (R)	0.1
Intrinsic uncertainty (instr. alone)	± 0.5% ± R
Temperature	
Measurement range (instr. alone)	- 10 to + 120°C (14 to 248°F)
Resolution (R)	0.1 °C (0.1°F)
Intrinsic uncertainty (instr. alone)	< 0.4°C (<0.7°F)
Available reference temperature	20/25 °C (68/77°F)
Calibration	1 point, 6 predefined conductivity reference standards (user-modifiable); Possibility of resetting to default calibration
Temperature compensation	
Temperature compensation mode	Automatic (ATC) or manual (MTC) linear, non-linear
Conductivity sensor	
Type	XCP4ST1 (supplied), 4-pole conductivity sensor with built-in temperature sensor (Pt 1000)
Connector	8-pin DIN, 1 m cable
Data storage	
Memory	> 100,000 measurements
Sensor input	8-pin DIN (adapters for BNC, S7 and Jack available as an option)
Communication interface	Type B micro-USB (USB device), 12 Mbit/s
Power supply	
Number – Type	4 x 1.5 V AA or LR06 alkaline batteries
Auto power-off	After 3, 10 or 15 min without use (adjustable)
Protection rating	IP67
Dimensions (with sheath)	211 x 127 x 54 mm
Weight (without sensor)	600 g
Warranty (instr. alone)	2 years

CA 10141 state at delivery

CA 10141 delivered in site-proof hard case with: 1 x 4-pole conductivity cell with built-in XCP4ST1 temperature probe, 4 x 1.5 V LR06 batteries, 1 protective sheath mounted on the instrument, 1 x 1408 µS/cm conductivity solution, 1 plastic beaker, 1 USB – micro USB cable, 1 wrist strap

CA 10141 accessories and replacement parts

147 µS/cm reference standard conductivity solution	P01700117
1408 µS/cm reference standard conductivity solution	P01700118

CA 10101 watertight portable pH-meter

The CA 10101's extra-wide, multi-display LCD screen makes it particularly comfortable to read and it offers storage on request of more than 100,000 time/date-stamped measurements (PC software included)



IP 67

DATA LOGGER

SPECIFICATIONS	Measurement parameters	
Reference	P01710010	
Measurement range (instrument only)	pH	-2.00 to 16.00 pH*
	Redox	±199.9 mV -1999 to -200 and +200 to +1999 mV
	Temperature	-10.0 to +120.0°C / 14.0 to 248.0°F
Resolution (R)	pH	0.01 pH
	Redox	0.1 mV 1 mV
	Temperature	0.1 °C / 0.1 °F
Intrinsic uncertainty of the instrument (without the electrode)	pH	± 0.01 pH ± r
	Redox	± 0.1 mV ± r ± 1 mV ± r
	Temperature	< 0.4°C / < 0.7°F
Calibration	pH	Automatic, up to 3 points, 3 groups of predefined reference solutions (modifiable)
	Redox	Automatic, 1 point, two predefined reference solution values (modifiable)
Temperature compensation	Automatic (ATC) or manual (MTC), -10°C to +120°C (14°F to 248°F)	
Electrode	pH	XRGST1 (supplied): pH combination electrode with built-in temperature sensor (Pt1000) and 8-pin DIN connector
	Redox	XRPTST1 (option): ORP combination electrode with built-in temperature sensor (Pt1000) and 8-pin DIN connector
Data storage	Date and time	Yes
	Data storage	> 100,000 measurements
Connectors	Sensor input	8-pin DIN (adapters for BNC, S7 and Jack available as options)
	Communication interface	Type B Micro-USB (USB peripheral)
Batteries / Life span	4 x 1.5 V AA or LR6 alkaline batteries / Approx. 300 hours of continuous use Auto power-off after 3, 10 or 15 min of inactivity (adjustable)	
Ingress protection	IP67	
Environmental conditions	Storage range (excluding batteries, electrodes and buffer solutions)	-20 to + 70°C
	Operating range	-10 to +55 °C
Dimensions (with sheath)	211 x 127 x 54 mm	
Weight (without electrode)	600 g	
Warranty (instrument only)	2 years	

* Instrument + XRGST1 pH electrode, 1.00 to 12.00 pH

State at delivery

1 CA 10101 pH-meter delivered in a site-proof case with 1 XRGST1 pH combination electrode with built-in temperature sensor, 4 AA or LR6 alkaline batteries, 1 protective sheath mounted on the instrument, 2 ready-to-use buffer solutions (compliant with NIST/DIN) with pH 4.01 and 7.00, 2 plastic beakers, 1 USB - micro USB cable, 1 wrist strap, quick start-up guides (one per language).

Accessories and replacement parts

XRGST1 pH combination electrode with built-in temperature sensor	P01710051	pH 10.01 buffer solution (NIST), 125 mL	P01700109
XRPTST1 ORP combination electrode with built-in temperature sensor	P01710052	220 mV ORP buffer solution, 125 mL.....	P01700114
pH 1.68 buffer solution (NIST)**, 125 mL.....	P01700105	468 mV ORP buffer solution, 125 mL.....	P01700115
pH 4.01 buffer solution (NIST), 125 mL.....	P01700106	Shockproof sheath.....	P01710050
pH 7.00 buffer solution (NIST), 125 mL.....	P01700107	Set of 3 beakers.....	P01710056
pH 9.18 buffer solution (NIST), 125 mL.....	P01700108	8-pin DIN to BNC & Jack adapter***	P01295501
		8-pin DIN to S7 & Jack adapter	P01295502

** Delivered with a quality certificate guaranteeing compliance with the NIST (National Institute of Standards and Technology) and DIN 19266 standards.

*** Connection adapters for Chauvin Arnoux pH/redox and temperature sensors



THERMOGRAPHY

CA 1950 and CA 1954 thermal cameras,
the perfect match between performance and technology!

DiaCAM

IP
54



120
X
160

80
X
80



Strengths

- > Exceptional battery life
- > Rapidity: startup in 3 seconds
- > An emissivity table which can be enhanced as required
- > Possibility of renaming the images and thermograms per site
- > Recording and storage of the configurations according to the applications
- > Voice annotations to record your comments directly on the image
- > Connectivity with current clamps and multimeters: all the measurements necessary simultaneously
- > Bluetooth™ communication
- > CamReport analysis and report creation software
- > Built-in slide-down protective cover

Scan this code
to watch the
presentation video



Voice recording

Voice recording using the Bluetooth earpiece delivered as standard



Simultaneous recovery via Bluetooth of the measurements made with:

- multimeters or clamp meters (current, etc.)
- thermometers, thermo-hygrometers (ambient temperature, humidity, dew point, etc.)



APPLICATIONS

Detect any thermal faults quickly & simply!

Electrical inspections



Thermal inspections

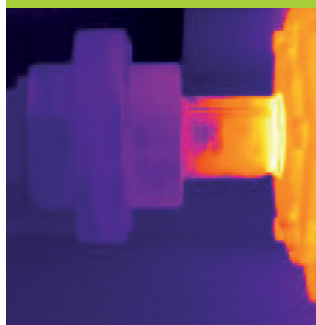

Mechanical inspections Construction

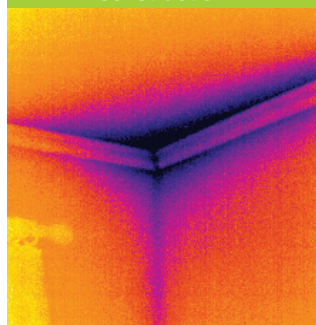

Radiator inspections

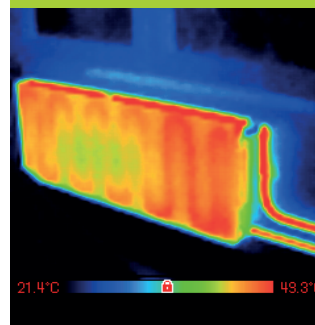

	CA 1950	CA 1954
Reference	P01651901	P01651904
Detector	80 x 80	120 x 160
Sensitivity (NETD)	80 mK @ 30 °C (0.08 °C @ 30 °C)	
Temperature range	-20 °C to +250 °C	
Accuracy	±2 °C or ±2 % of reading	
Field of view	20° x 20°	28° x 38°
IFOV (spatial resolution)	4.4 mrad	4.1 mrad
Focusing	Fixed	
Real image	Yes	
Measurement tools	1 manual cursor, automatic Min-Max detection, temperature profile, isotherm	
Parameter settings	Emissivity, environmental temperature, distance, relative humidity	
Voice comments	Yes by Bluetooth (earpiece supplied)	
Connectivity	F407, F607, MTX 3292 and MTX 3293 clamp meters, environmental measurement products (CA 1821, CA 1822, CA 1823, CA 1246)	
Data storage	On removable 2 GB micro SD card (approx. 4,000 images), up to 32 GB possible	
Battery life	13 hrs 30 min	9 hrs
Type	NIMH rechargeable batteries with low self-discharge or alkaline batteries	
Ingress protection	IP 54	
Resistance	Fall from 2 metres	
Dimensions and weight	225 x 125 x 83 / 700g with rechargeable batteries	

State at delivery

CA 1950 and CA 1954 delivered in site-proof case with 4 NiMH batteries and 1 battery charger, 1 micro SD HD card, 1 USB cable, 1 Bluetooth earpiece, the CAMReport software on CD ROM, User's Manuals and a measurement report.



THE BEST SOFTWARE FOR ANALYSING THERMOGRAMS!



CAMReport software included



The CAMReport software is supplied as standard with the CA 1950 & CA 1954 cameras.

It offers all the functions needed for reliable analysis of your measurement results:



Strengths



- Cursors (automatic display of the temperature at the chosen point)
- Thermal profile (automatic display of the Min/Max/Avg temperatures of the line)



- A square or circle for zone analysis
- Results tables quickly and automatically display all the information/analytical tools for the thermogram



- Polygons and polylines for more precise analysis of certain zones in the thermogram
- User-enhanceable emissivity table supplied as standard
- Ready-to-use, customizable report templates



Reports are created automatically using the various templates available

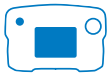

CA 6528 digital insulation tester

	CA 6528
Reference	P01140838
Voltage	
Measurement range / resolution	1-700V / 1V
Accuracy / input impedance	±1.2% reading ± 1pt in AC+DC ; ±1% reading ± 1 ct in DC / 25 MΩ
Operating frequency	DC; 30-440 Hz
Insulation	
Test voltage	250-500-1000 V
Range at maximum test voltage	11 GΩ
Measurement range	250 V : 50 kΩ - 4.2 GΩ / 500 V : 100 kΩ - 4.2 GΩ / 1,000 V : 200 kΩ - 11 GΩ
Measurement range / resolution	50 kΩ - 3.999 / 1kΩ; (0.2)1 3.6-39.99 MΩ / 10 kΩ; 36-399.9 MΩ / 100 kΩ; 360-4,200 MΩ / 1 MΩ; (1kV) 3.6 - 11.00 GΩ / 10 MΩ
Accuracy	0.05-399.9 MΩ: ±1.5% reading ± 10 cts; 360 -4,200 MΩ: ±4% reading ± 10pt; ±4% reading ± 5 cts (at 1,000V); 3.6-11 GΩ: ±10% reading ± 10 cts
Timer (min:s)	10 s to 39 min 59 s
Alarms	1 threshold / test voltage
Continuity	
Measurement range	0.02 Ω - 40 Ω (200 mA)
Accuracy / Open-circuit voltage	±1.2% reading ±3 cts / 6 VDC < U < 9 VDC
Measurement current	≥ 200 mA (up to 2 Ω)
Continuity thresholds (fast beep)	2 Ω / 1 Ω
Cable compensation	up to 5 Ω
Resistance	
Measurement range / resolution	1 -399.9 Ω / 0.1 Ω -360-2 999 Ω / 1 Ω - 3.60-39.99 kΩ / 10 Ω - 36.0-420.0 kΩ / 100Ω
Accuracy	±1.2% reading ± 3 cts
General specifications	
Display	2 x 4,000 cts
Power supply / Auto power-off	6 x LR 6 or AA batteries / 10 min, deactivatable
Battery life	1,000 measurements: at 1 MΩ @ 1 kV (5 s ON / 25 s OFF) ; >3,000 continuity measurements (5 s ON / 25 s OFF) at 1 Ω
Dimensions / weight / IP rating	218 x 95 x 63 mm / 760 g / IP 40
EMC / Electrical safety	IEC 61326-1 / IEC 61010-1, IEC 61010-2-030 and IEC 61010-2-034 / 600V CAT IV
Compliance with standards	IEC 61557 parts 1, 2, 4 and 10



NEW PRODUCT*

1000 V
CAT III

600 V
CAT IV

IP
40

State at delivery

CA 6528 delivered in a hands-free bag containing: 2 safety leads - 1 red and 1 black, 1 red crocodile clip, 1 black test probe, 1 protective sheath mounted on the instrument, 6 x LR6 or AA batteries, 1 safety datasheet, 1 quick start-up guide, 1 verification certificate

Accessories and replacement parts

Set of red and black 1.5 m safety leads	P01295289Z
Red + black crocodile clips	P01295457Z
Red + black test probes.....	P01295454Z
Continuity rod.....	P01102084A

*Available soon

CA 6011 installation tester

- Dedicated to testing the continuity of protective earth conductors
- Double configuration: built-in continuity tester on the reeling box and remote continuity tester on wrist

300 V
CAT III

IP
40



IEC
61557-4



State at delivery

CA 6011 KIT delivered with: 1 elastic strap for fastening the measurement unit to your wrist, 1 waist belt + 1 shoulder strap, 1 "Cable Reeler No. 01" with 1 green PVC cable 30 m long, 1 black PVC spiral cable 3.5 m long, 1 green crocodile clip with Ø 4 mm banana socket, 1 moulded black test probe, 1 green PVC cable 0.50 m long, 1 set of 4 x 1.5 V LR06 alkaline batteries

Accessories and replacement parts

Cable reeler no. 1 30m	P01295492
Continuity rod.....	P01102084A

	CA 6011
Reference	P01299926
Display	2,000 counts with 2-colour backlighting
Continuity	
Measurement range	0,00 Ω to 2,00 Ω 2,00 Ω to 20,00 Ω
Resolution	10 mΩ
Measurement current	200 mA 20 mA
Open-circuit voltage	with automatic polarity reversal
Resistance	±(4 VDC < U < 6 VDC)
Measurement range	1,0 Ω to 200,0 Ω
Resolution	100 mΩ
Measurement current	10 mA
Open-circuit voltage	±(4 VDC < U < 6 VDC)
Continuity threshold	Programmable, 1Ω or 2Ω
Cable resistance compensation	Yes
Indication of test conformity/non-conformity	Configurable: visual, audible and/or vibrating
Compliance with standards	IEC 61557-1 & IEC 61557-4 IEC 61010-1, IEC 61010-2-030 300V CAT IV
Automatic standby mode	10 minutes / deactivatable
Battery life	30,000 measurements in real use 4,500 as per IEC 61557-4 protocol
Power supply	4 x 1.5 V AA/LR6 batteries
Dimensions (instrument+reeler)	225 x 185 x 135 mm
Weight	CA 6011 alone: 350g Reeler with 30 m cable: 1.2 kg

CA 6422 and CA 6424 Earth/ground testers

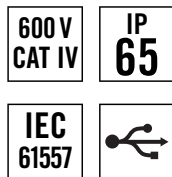

NEW PRODUCTS*



	CA 6422	CA 6424
Reference	P01127012	P01127014
Voltage (UHE)		
Range	-	0.1-600V
Resolution	-	0.1V
Accuracy	-	± (1% reading + 1 ct)
2P resistance		
Range	0.05-99.99 Ω / 80.0-999.9 Ω / 0.800-9.999 kΩ / 8.00-50.00 kΩ	
Resolution		0.01 Ω / 1 Ω / 10 Ω / 100 Ω
Accuracy	± (2% reading + 10 ct) / ± (2% reading + 2 cts) / ± (2% reading + 1 ct) / ± (2% reading + 1 ct)	
Cable compensation	-	up to 5 Ω
3P earth/ground resistance		
Range	0.5 Ω - 2.000 kΩ	0.5 Ω - 50.00 kΩ
Resolution	0.01 Ω / 0.1 Ω / 1 Ω	0.01 Ω / 0.1 Ω / 1 Ω / 10 Ω
Accuracy	±(1% reading + 10 cts) / ±(1% reading + 2 cts) / ±(1% reading + 1 ct)	
Measurement frequency	128 Hz or 256 Hz	
Open-circuit voltage	± 10 V peak	
Measurement mode	One-shot or permanent	
Data storage		RE registers @ 62%; RE @ 52%; RE @ 72%
Calculation of the average	-	calculation of the average and % deviation in relation to the average
RH stake resistance measurement		
Range	-	0.05-9.999 kΩ / 8 - 49.99 kΩ
Resolution	-	1 Ω / 10 Ω
Accuracy	-	±(10% reading + 1 ct)
U _{SE} voltage measurement	No	
Range	-	0.10 - 99.99 VAC / 80.0 - 600 VAC
Resolution	-	0.01 V / 0.1 V
Accuracy	-	±(2% reading + 2 cts) ±(2% reading + 2 cts)
Current resistance (via optional G72 clamp)		
Range		0.5 - 999.9 mA / 0.800-9.999 A / 8.00-60.00 A
Resolution		0.1 / 1 / 10 mA
Accuracy		±(1% reading + 4 cts) / ±(1% reading + 2 cts)
Display	206-segment backlit Custom LCD	
Measurement mode	R 2P (Ω), R 3P (Ω)	V, I, R 2P (Ω), R 3P (Ω)
Power supply	6 x LR 6 or AA batteries	6 NiMH rechargeable batteries, charging time approx. 6 hrs
Charger	-	Internal via mains / USB adapter supplied
Automatic power-off	-	Deactivatable
Battery life	> 2000 x 3P measurements at 100 Ω	> 1,500 3P earth measurements at 100 Ω
Dimensions / weight	223 x 126 x 70 mm / 1 kg	
Environment	Operation: -10 to +50°C / Storage: -40 to +70 °C (without batteries or rechargeable batteries)	
Protection	Up to 600 V on any of the 3 input terminals	
IP / IK rating	IP 65 as per IEC 60529 / IK 04 as per IEC 50102	
Fall test	1 metre as per IEC 61010-1	
Standards / Electrical safety	EMC: IEC 61326-1 ; IEC 61010-2-030 / 600 V CAT IV	
IEC 61557 compliance	IEC 61557-1 and IEC 61557 -4	

*Available soon

State at delivery

CA 6422 delivered with 6 x LR6 AAA batteries, 1 quick start-up guide, 1 safety datasheet, 1 test report with measurement results, downloadable user's manuals

CA 6424 delivered with 1 bag, 6 NiMH batteries, 1 USB 2A power pack, 1 USB micro-razor power cable, 1 multilingual quick start-up guide, 1 safety datasheet, 1 battery information sheet, test report with measurement results, downloadable user's manuals

Accessories and replacement parts

Bag	P01298006
G72 current clamp	P01120872
4-point hands-free strap	HX0302
15m earth/ground kit.....	P01102017
50m expert earth/ground kit.....	P01102021

Installation tester

Test the electrical safety of your installations



Discover our new CA 6133 electrical installation tester

- > Earth measurement by stake and loop methods
- > Continuity measurement at 0.2A
- > Isolation test
- > RCD test: tripping current and time
- > Automatic test sequences
- > Storage of the tests in memory
- > ANDROID application for report generation
- > Power supply by mains-rechargeable batteries: USB socket or vehicle cigarette lighter



Connected!

The ANDROID IT-Report application can be used to transfer the test results stored in the CA 6133 onto a tablet or smartphone via Bluetooth. Test reports are generated and then sent automatically by email or simply stored for later processing.



State at delivery

- **CA 6133 :**
Delivered with 1 carrying bag containing:
 - 1 neck strap
 - 1 EURO 3-pole cable
 - 3 safety leads
 - 3 crocodile clips
 - 1 test probe
 - 1 x 2A USB power supply + 1 USB cable
 - 6 Ni MH batteries (CA 6133)
 - 1 test report with measurement report



Reference

- CA 6133.....P01146013

CA 6133	
CONTINUITY / RESISTANCE	
Range / Resolution / Accuracy	0.00 to 9.99 Ω — Cable compensation up to 5 Ω; I ≥ 200 mA / 0.01 Ω / ± (2 % R + 2 cts)
Range / Resolution / Accuracy	1 to 9,999 Ω • 10.00 to 99.99 kΩ / 1 Ω • 10 Ω / ± (1 % R + 5 cts)
INSULATION	
Rated voltage	Utest: 250 V / 500 V / 1,000 V
Range / Resolution / Accuracy	0.01 to 999.9 MΩ / 10 kΩ • 100 kΩ / ± (3 % R + 3 cts)
Short-circuit current	≤ 3 mA
3P EARTH	
Range / Resolution / Accuracy	0.50 – 99.99 Ω / 0.01 Ω / ± (2 % R + 10 cts) 100.0 to 999.9 Ω / 0.1 Ω / ± (2 % R + 5 cts) 1,000 to 2,000 Ω / 1 Ω / ± (2 % R + 5 cts)
(Zs (L-PE) and Zi (L-N or L-L) LOOP IMPEDANCE	
Installation voltage / Frequency	90 to 550 V / 45 to 65 Hz
High current mode with TRIP: Zs (L-PE) & Zi (L-N or L-L) Range / Resolution / Accuracy	300 mA measurement current; 0.1 to 0.9 Ω • 1.0 to 399.9 Ω / 0.1 Ω / ± (2 cts) • ± (5 % R* + 2 cts)
NO TRIP mode (Zs (L-PE) only)	Measurement current: 12 mA • 1 to 19 Ω • 20 to 39 Ω 40 to 2,000 Ω / 1 Ω / ± (2 cts) • ± (15 % R + 3 cts) • ± (5 % R + 2 cts)
Calculation of Ik short-circuit current (PFC (Zs)) , (I Sc PSCC (Zi))	1 to 999 A, 1 to 9,999 A
TYPE AC and A RCDs	
Installation voltage / Frequency	90 to 450 V ; 45 to 65 Hz
IΔn	30 mA - 100 mA - 300 mA - 500 mA - 650 mA
NO TRIP test	300 ms
Ramp mode (30 mA)	12 mA (Uf) / 0.3 to 1.06 x IΔn per step of 3.3 % x IΔn
Trip time measurement: Range / Resolution / Accuracy	Pulse: 5 to 300 ms / 0.1 ms / ± 2 ms
Automatic test sequence	RCD, Loop-RCD-Isolation
OTHER MEASUREMENTS	
Current via MN73A clamp	2A range: 10.0 mA to 2,400 mA, 200 A range: 1.00 to 200 A
Voltage Range / Resolution / Accuracy	2.0 to 550.0 VAC / 0.1 V / ± (1%R+2cts) ; 0.0 to 800.0 VDC / 0.1 V / ± (1%R+2cts)
Frequency Range / Resolution / Accuracy	30.0 to 999.9 Hz / 0.1 Hz / ± (0.1 % R + 1 ct) Voltage > 2V
Phase rotation	45 to 550 V / 45 to 65 Hz
GENERAL SPECIFICATIONS	
Display	231-segment LCD with blue backlighting
Storage / Communication	30 sites x 99 tests / Bluetooth Class 1; range > 10m
Power supply / battery life	6 NiMH mains-rechargeable batteries < 6 hrs , USB or cigarette lighter/ 1,700 x 1 Ω continuity measurements
Dimensions / weight	223 x 126 x 70 mm / 700 g approx.
Ingress protection / EMC	IP 54; IK 04 / EMC: IEC 61326-1 IEC 61010-1 ; IEC 61010-2-030 ; IEC 61010-2-034, 600V CAT III, 300V CAT II (charger)/ Compliant with IEC 61557 parts 1,2,3,4,5,6,7,10
Electrical safety	

Accessories and replacement parts

- Type 4 remote control probe..... P01102157
- MN73A current clamp for CA 6133..... P01120439

Installation testers

600 V
CAT III

IP
53



	CA 6116N	CA 6117
BONDING / RESISTANCE		
I rated / Range / Resolution	I > 200 mA / 39.99 Ω / 0.01 Ω / ± (1.5 % of reading + 2 cts) 12 mA / 39.99 Ω and 399.9 Ω / 0.01 and 0.1 Ω / ± (1.5 % of reading + 5 cts) with buzzer	
Range/ Resolution / Accuracy	4 kΩ / 1 Ω / ±(1.5 % of reading + 5 cts) • 40 kΩ - 400 kΩ / 10 Ω - 100 Ω / ±(1.5 % of reading + 2 cts)	
ISOLATION		
Rated voltage	U _{test} : 50 / 100 / 250 / 500 / 1,000 V DC	
Range / Basic accuracy	0.01 MΩ to 2 GΩ / 10 kΩ to 1 MΩ / ±(5 % of reading + 3 cts)	
Short-circuit current	≤ 3 mA	
EARTH		
3P earth	0.50 Ω to 40 Ω / 0.01 Ω / ±(2 % of reading + 10 cts) • 40 Ω to 15 kΩ / 0.1 Ω to 1 Ω / ±(2 % of reading + 2 cts) 15 kΩ to 40 kΩ / 10 Ω / ±(10 % of reading + 2 cts)	
Range / Resolution / Accuracy		
Others	Resistance measurement of RH & RS auxiliary stakes (up to 40 kΩ)	
U _{fk}	Compliant with SEV 3569	
1P SELECTIVE EARTH	0.50 Ω to 39.99 Ω - 40 Ω to 399.9 Ω / 0.01 Ω - 0.1 Ω / ±(10 % of reading + 10 cts) (ISel via clamp)	
Range / Resolution / Accuracy		
LOOP IMPEDANCE (Z_s (L-PE) and Z_i (L-N or L-L) - 1P LIVE EARTH		
LIVE EARTH	90 to 500 V / 15.8 to 17.5 Hz - 45 to 65 Hz	
Installation voltage / frequency		
High current TRIP mode	Max. test current: 7.5 A	
Z _s (L-PE) & Z _i (L-N or L-L)	(0.050) 0.100 Ω to 0.5 Ω / 0.001 Ω / ± (10 % of reading + 20 cts) • 0.5 Ω to 3.999 Ω / 0.001 Ω / ± (5% of reading + 20 cts) 3.999 to 39.99 Ω / 0.01 Ω / ± (5 % of reading + 2 cts) • 40.0 Ω to 399.99 Ω / 0.1 Ω / ± (5% of reading + 2 cts)	
Range / Resolution / Accuracy		
NO TRIP mode	Test current: 6 mA - 9 mA - 12 mA (as required) • 0.20 Ω to 0.99 Ω / 0.01 Ω / ± (15 % of reading + 10 cts) 1.00 to 1.99 Ω / 0.01 Ω / ± (15 % of reading + 3 cts) • 2.00 to 39.99 Ω / 0.01 Ω / ± (10 % of reading + 3 cts) 40.00 Ω to 399.9 Ω / 0.1 Ω / ± (5 % of reading + 2 cts) • 400 to 3,999 Ω / 1 Ω / ± (5 % of reading + 2 cts)	
(Z _s (L-PE) only)		
Calculation of short-circuit current I _k (PFC (Z _s), I _{Sc} PSCC (Z _i))	Fault and short-circuit current: 0.1 A to 20 kA	
Table of integrated fuses	Yes	
Voltage drop ΔV%(Z _i)	-40 % to +40 %	
Others	Measurement of the resistive and inductive components of the impedances Z _s and Z _i	
TYPE AC and A RCDs		
Installation voltage / Frequency	90 V to 500 V / 15.8 Hz to 17.5 Hz and 45 Hz to 65 Hz	
IΔn	6/30/100/300/500/650/1000 mA (90 V - 280 V) or variable 6/10/30/100/300/500 mA (280 V - 550 V) or variable	
No Trip test	At ½ IΔn - Duration: 1,000 ms or 2,000 ms	
Ramp mode	0.2 to 0.5 x IΔn (U _f) / 0.3 x IΔn to 1.06 x IΔn in increments of 3.3 % x IΔn	
Tripping time measurement: Range / Resolution / Accuracy	0.2 to 0.5 x IΔn (U _f) / 0.5 x IΔn / 2 x IΔn (selective) / 5 x IΔn Pulse: 0 to 500 ms / 0.1 and 1 ms / 2 ms, Ramp mode (10) to 200 ms / 0.1 ms / 2 ms	
TYPE B RCDs		
Installation voltage / frequency	90 V to 280 V / 15.8 Hz to 17.5 Hz and 45 Hz to 65 Hz	
IΔn: ramp / pulse 2 x IΔn	6/10/30/100/300/500 mA	
pulse 4 x IΔn	6/10/30/100 mA with 4 IΔn pulse	
Test in ramp mode	Duration: 150 ms in 4 x IΔn or 300 ms with 2 x IΔn	
Tripping time:	0.2 x IΔn to 2.2 x IΔn IΔN ≤ 200 mA : 2.2 x 2 x IΔn IΔN > 200 mA : 1.1 x 2 x IΔn IΔN ≤ 100 mA : 2.2 x 4 IΔN	
OTHER MEASUREMENTS		
Current via C177A clamp	5.0 mA to 199.9 A (C177A)	
Current via MN77 clamp	(1 mA*) 5.0 mA to 19.99 A	
Voltage	0 to 550 VAC/DC / DC and 15.8 to 450 Hz	
Frequency	15.8 to 500 Hz	
Phase sequence	20 to 500 VAC	
Active power	0 to 110 kW single-phase - 0 to 330 kW three-phase - Simultaneous display of voltage and current waveforms	
Harmonics	Voltage and current / up to 50th order / THD-F / THD-R	
GENERAL SPECIFICATIONS		
Display	Large 5.7" backlit colour graphical LCD screen, 320 x 240 points	
Storage/Communication	1,000 tests / via USB for data transfer and report creation	
Power supply / Battery life	Lithium-ion rechargeable battery rated 10.8 V 5.8 AH / up to 30 hours	
Dimensions / weight	280 x 190 x 128 mm / 2.2 kg	
Ingress protection / EMC	IP 53 / IK04 / IEC 61326-1	
Electrical safety	IEC 61010 -1 - 600 V CAT III - 300 V CAT IV - IEC 61557	

* if a voltage is connected to the instrument

State at delivery

• CA 6116N • CA 6117:

1 tester delivered with a carrying bag, 1 type-2 mains power pack / charger, 1 Li-Ion battery pack, 1 USB A/B cable 1.50 m long, 1.80 m, with ferrite, 1 three-point cable - 3 safety leads (red, blue and green), 3 test probes, Ø 4mm (red, blue and green), 3 crocodile clips (red, blue and green), 2 elbowed-straight safety leads, 3 m (red and black), 1 three-point Euro mains cable, 1 x 2P EURO mains cable, 1 remote-control probe, 1 wrist strap, 1 scratch-proof film mounted on the instrument, 1 x 4-point hands-free strap, ICT data export software on CD-ROM, 6 operating manuals on CD (one per language), 1 safety datasheet in 20 languages.

References

- CA 6116N EURO Contrôleur **P01145455 X***
- CA 6117 EURO Contrôleur **P01145460 X***

* version GB : X = A, version IT : X = B,
version CH : X = C, version US : X = D





Insulation and Continuity Testers

Discover our new range:

- > Test voltage from 10 V to 1,000 V / 200 GΩ
- > Manual, Lock, Timer and PI / DAR Ratios modes
- > Visual Pass / Fail: red / green
- > 200 mA / 20 mA continuity with active protection without fuses
- > Measurement of V (TRMS & DC), F, Ω, kΩ, C and cable length
- > ΔRel mode & configurable alarms
- > Storage of measurements in memory



600 V
CAT IV

IP
54

IEC
61557



TRMS

Choose your tester to match your needs:

CA 6536

"Special & ESD" applications

With a variable test voltage from 10 V to 100 V in 1 V increments, this model is intended for special applications in sectors such as avionics, space and defence, which often require a low test voltage and strict adherence to the programmed value. With appropriate electrodes, the 10 V and 100 V test voltages can also be used for electrostatic discharge applications.

CA 6532

"Telecommunications" applications

- Insulation tests at 50 V or 100 V
- Specific functions: measurement of resistance, capacitance, leakage current and AC voltage.
- Measurement of the difference in resistance between 2 wires in a pair by using the ΔREL function.
- Display of the length of the line being tested, thanks to programming of the linear capacitance in nF/km.

CA 6522, CA 6524, CA 6526

"Industrial Maintenance" applications

- Periodic insulation tests on installations and equipment help to prevent incidents by setting up preventive maintenance designed to detect ageing and premature deterioration of their insulation characteristics:
- Measurement of insulation over a programmed duration
 - Alarms and Pass/Fail indicator light (CA 6526)
 - PI and DAR ratios to determine the quality of the insulation, with the advantage of not being significantly influenced by the temperature
 - Storage in memory to compare the measurement histories

CA 6534

"Electronics" applications

Thanks to its wide test-voltage range from 10 V to 500 V, this model covers the specific requirements of the electronics industries, for both low-current applications and power stages. Its measurement range is from 2 kΩ to 50 GΩ.

Remote control probe

The remote control probe is an accessory specially developed to make your insulation tests in the field simpler and quicker.

- Insulation measurement can be triggered with a single press on the probe's yellow button.
- Equipped with a torch function, this probe effectively lights the point of measurement.
- Thanks to the tester's backlit screen, the measurement results are visible at all times, including in places with poor lighting.



Reference P01102092A

DataView® software

DataView® software, with its Megohmmeter Transfer module, automatically recognizes the instrument when it is connected to the PC and opens the corresponding menu. This tree-structure menu offers users direct access to the data recorded in the instrument and its configuration.

The other functions available are:

- Activation of remote tests
- Real-time display
- DAR and PI references
- Graphical plot of the tests
- Generation of measurement reports

Reference P01102095





	CA 6522	CA 6524	CA 6526	CA 6532	CA 6534	CA 6536
Reference	P01140822	P01140824	P01140826	P01140832	P01140834	P01140836 / P01299974
Application	Industrial Maintenance			Telecom	Electronics / ESD	Specials & ESD / Kit ESD
Voltage						
Measurement range / Resolution	0.3V - 399.9 V / 0.1 V; 400V-700V / 1V					
Accuracy / Input impedance	+/- (3% + 2cts) / 400 kΩ					
Operating frequency	DC; 15.3 - 800 Hz					
Frequency						
Measurement range / Resolution / Accuracy	15.3 Hz- 399.9 Hz / 0.1 Hz / +/- (0.5% + 2cts) ; 400-800 Hz / 1 Hz / +/- (1% + 1ct)					
Insulation						
Test voltage	250-500-1,000V	50 - 100 - 250 - 500 - 1 000 V		50 - 100 V	10 - 25 - 100 - 250 - 500 V	10 to 100V in 1V increments
Range at maximum test voltage	40 GΩ	200 GΩ		20 GΩ	50 GΩ	20 GΩ
Compliance with IEC 61557-2 standard		2 GΩ		2 GΩ		2 GΩ
Measurement range: 10 V					2 kΩ - 1 GΩ	2 kΩ - 2 GΩ
25 V					5 kΩ - 2 GΩ	(U _v /5) kΩ - (U _v /5) GΩ
50 V		10 kΩ - 10 GΩ		10 kΩ - 10 GΩ		
100 V		20 kΩ - 20 GΩ		20 kΩ - 20 GΩ	20 kΩ - 10 GΩ	20 kΩ - 20 GΩ
250 V	50 kΩ - 10 GΩ	50 kΩ - 50 GΩ			50 kΩ - 25 GΩ	
500 V	100 kΩ - 20 GΩ	100 kΩ - 100 GΩ			100 kΩ - 50 GΩ	
1,000 V	200 kΩ - 40 GΩ	200 kΩ - 200 GΩ				
Variable test voltage						10V to 100V
Measurement range / resolution	10 ⁽¹⁾ - 999 kΩ and 1,000 - 3,999 MΩ / 1 kΩ; 4.00 - 39,99 MΩ / 10 kΩ; 40.0 - 399.9 MΩ / 100 kΩ; 400 - 3,999 MΩ / 1 MΩ; 4.00 - 39,99 GΩ / 10 MΩ; 40.0 - 200 GΩ / 100 MΩ					
Accuracy	± (3 % + 2 cts) ⁽²⁾					
Test voltage (I < 1 mA)	-0 % + 20 %					
Display of test voltage	± (3 % + 3 cts)					
Display of test current / resolution	0.01 μA - 39.99 μA / 10 nA ; 40.0 - 399.9 μA / 100 nA; 0.400 - 2.000 mA/ 1 μA					
Accuracy of test current	± (10 % + 3 cts)					
PI/DAR ratios	10 mn / 1 mn - 1 mn / 30 s					
Timer (min:s)	0:00 - 39:59					
Discharge time (at 25 V)	< 2 s/μF					
Alarms	2 fixed thresholds + 1 programmable threshold					
Continuity						
Range for continuity measurement	0.00 Ω - 10.00 Ω (200 mA)	0.00 Ω - 10.00 Ω (200 mA); 0.0 - 100.0 Ω (20 mA)				
Accuracy / Open-circuit voltage	± (2 % + 2 cts) / ≥ 6 V					
Measurement current	-0%+4%					
Continuity thresholds (quick beep)	2 Ω fixed	2 Ω, 1 Ω, 2Ω, 1Ω, programmable threshold				
Compensation of cables	up to 9.99 Ω					
Resistance						
Measurement range / Resolution / Accuracy	0 - 3999 Ω / 1 Ω; 4,00 kΩ - 39,99 kΩ / 10 Ω / ± (3 % + 2 cts) 40,0 kΩ - 399,9 kΩ / 100 Ω; 400 kΩ - 1000 kΩ / 1 kΩ / ± (3 % + 2 cts)					
Capacitance						
Measurement range / resolution	0.1 nF - 399.9 nF / 0.1 nF 400 nF - 3999 nF / 1 nF 4.00 μF - 10.0 μF / 10 nF					
Accuracy	± (3 % + 2 cts)					
Line length	0 - 100 km					
General specifications						
Display	2 x 4,000 cts + logarithmic bargraph					
Storage	300 measurements	1,300 measurements				
Communication	Bluetooth® Classe II					
Power supply / Automatic shutdown	6 x LR6(AA) batteries / 5 min., deactivatable					
Battery life	1,500/2,500/6,000 measurements ⁽⁴⁾ ; UN x 1 kΩ @ UN (5s ON / 55 s OFF); 3,000 continuity measurements (5s ON / 55 s OFF)					
Dimensions (h x w x d) / Weight / IP rating	211 x 108 x 60 mm / 850 g / IP 54 / IK 04					
EMC / Electrical safety	IEC 61326-1 / IEC 61010-1 and IEC 61010-2-030, 600V CAT IV					
Compliance with standards	IEC 61557 parts 1, 2, 4 and 10					

(1) : 2 kΩ for CA 6532 - CA 6534 - CA 6536 - (2): to be added: 10 V: 1% per 0.1 GΩ ; 25 V: 0.4% per 0.1 GΩ ; 50 V: 2% per GΩ; 100 V: 1% per GΩ; 250 V : 0.4% per GΩ; 500 V: 0.2% per GΩ; 1,000 V: 0.1% per GΩ - (3): 10%/UN is added per 100 MΩ - (4): depending on the model.

Accessories and replacement parts

Continuity rod	P01102084A	2 wire grips (red and black)	P01102053Z
CA 861 thermometer + K thermocouple	P01650101Z	Carrying bag for hands-free use	P01298049
2 elbowed-straight safety leads (red and black) 1.50 m long.	P01295453Z		
2 crocodile clips (red and black)	P01295457Z		
2 test probes (red and black)	P01295454Z		

State at delivery

- **CA 6522 et CA 6524** delivered with a carrying bag for hands-free use, 2 elbowed-straight safety leads (red and black) 1.50 m long, one red crocodile clip, one black test probe, 6 x LR6 or AA batteries, multilingual user's manual on CD, a quick start-up guide, multilingual safety datasheet.
- **CA 6526**, ditto + a CD containing the Megohmmeter Transfer software.
- **CA 6532 and CA 6534**, same as CA 6526 + 2 wire-grips (red and black).
- **CA 6536**, same as CA 6524 + 2 wire-grips (red and black).





ELECTRICAL TESTING AND SAFETY

IP 53

Insulation testers



	CA 6541	CA 6543	CA 6505	CA 6545	CA 6547	CA 6549
	<i>Quantitative and qualitative measurement</i>	<i>Saving of measurements Rechargeable battery</i>	<i>Insulation and leakage current</i>	<i>Insulation, capacitance, current</i>	<i>Storage and communication</i>	<i>For preventive maintenance professionals</i>
Reference	P01138901	P01138902	P01139704	P01139701	P01139702	P01139703
Voltage	1 to 1,000 V _{AC/DC}		1 to 5,100 V _{AC/DC}			
Insulation	50 / 100 / 250 / 500 / 1,000 V _{DC}		500/1,000/ 2,500 / 5,000 V _{DC} + variable from 50 V to 5,100 V _{DC} (10 or 100 V increments)			
Range	2 kΩ to 4 TΩ		10 kΩ to 10 TΩ			
Continuity	0.01 to 40 Ω (buzzer + cable compensation)					
Resistance	0.01 to 400 kΩ					
Capacitance	0.005 to 4.999 μF		0.001 to 49.99 μF			
Current			0.001 nA to 3,000 μA			
Voltage ramp mode						5 steps
R calcul. (ref. T°)						yes
Alarms	yes					
Smoothed display	yes		no		yes	
Chronometer	yes					
Prog. test time	yes					
Quality ratios	DAR / PI			DAR / PI / DD		
R(t)	storage of samples		no	storage of samples		display on screen
Storage		128 kB		4 kB		128 kB
Communication		two-way		no		two-way
Power supply	8 x LR14 batteries		NiMH rechargeable battery			
Safety	IEC 61010-1 Cat. III 600 V IEC 61557		IEC 61010-1 Cat. III 1000 V (Cat. I, 2,500 V)- IEC 61557			
Display	giant LCD + bargraph		giant LCD + bargraph			graphic
Backlighting	yes					
Dimensions	240 x 185 x 110 mm		270 x 250 x 180 mm			
Weight	3.4 kg		4.3 kg			
PC software	no	DataView® (option)	no	no		DataView® (option)
State at delivery	carrying bag containing: 3 leads 1.5 m long (including one shielded), 3 crocodile clips, 1 test probe + batteries or power cable		carrying bag containing: 3 HV leads 2 m or 3 m long with large crocodile clips (including one shielded), 1 lead with rear connection (35 cm) + 1 power cable			

DataView® software for CA 6543, CA 6547 and CA 6549

DataView®:

the essential tool for configuring and performing the measurements, viewing the data in real time, recovering the recorded data and creating standard or customized measurement reports..... **P01102095**

Accessories and replacement parts

CA 1246 thermo-hygrometer for CA 6505/6545/6547/6549.....	P01654246
CA 1821 thermometer.....	P01654821
Remote-control probe for CA 6541/CA6543	P01101935

Digital insulation testers

- > Wide measurement range from 10 kΩ to 30 TΩ
 - 5 mA charging current
 - Large backlit LCD screen with digital display, bargraph and R(t)+u(t), i(t) and i(u) graphs
 - Automatic calculation of DAR / PI / DD / ΔR (ppm/V) ratios
- > 3 filters to optimize measurement stability



**1000 V
CAT IV** **IP
54**

	CA 6550	CA 6555
Reference	P01139705	P01139706
Voltage	10 kV	15 kV
Insulation	500/1,000/2,500/5,000/10,000 V	500/1,000/2,500/5,000/10,000/15,000 V
Range	10 kΩ to 25 TΩ	10 kΩ to 30 TΩ
Resistance	Yes	
Capacitance	0.001 – 9.999 μF / 10.00 – 19.99 μF	
Current	Leakage current from 0 to 8 mA	
Voltage ramp mode	3 pre-configurable ramps	
R calcul. (ref. T°)	Yes	
Alarms	Yes	
Smoothed display	Yes	
Chronometer	Yes	
Prog. test time	Yes	
Quality ratios	DAR / PI / DD / ΔR (ppm/V)	
R(t)	Display on screen	
R(t) + U(t), I(t), I(u)	Graphic display of curves	
Storage	256 kB, up to 80,000 recordings	
Communication	Optically-isolated port for USB link	
Power supply	NiMH battery rechargeable with external voltage	
Safety	1,000 V Cat. IV - IEC 61010-1 and IEC 61557	
Backlighting	Yes	
Dimensions	340 x 300 x 200 mm	
Weight	6.2 kg	

State at delivery

Delivered with bag containing :

- 2 safety leads 3m long equipped with an HV connector at each end (red / blue),
- shielded safety lead 3 m long equipped with an HV connector at one end and an HV connector with rear connection (black) at the other end,
- 3 crocodile clips (red, blue, black),
- 2 x CAT IV 1000 V test probes (red, black) for voltage measurement,
- 1 blue lead with rear connection,
- 1 mains power cable 2 m long,
- DataView® software,
- 1 optical / USB communication lead,
- 1 operating manual in 5 languages on CD-ROM

Accessories

3 HV leads with croc. clips for 10/15 kV	P01295466
Blue 8 m HV lead with croc. clips	P01295468
Red 8 m HV lead with croc. clips	P01295469
Black 8 m HV lead with croc. clips	P01295470
Blue 15 m HV lead with croc. clips	P01295471
Red 15 m HV lead with croc. clips	P01295472
Black 15 m HV lead with croc. clips	P01295473
3 x 3 m HV leads for 10/15 kV.	P01295465
50 cm HV lead with rear connection	P01295467
2 red/black test probes	P01295454Z
3 crocodile clips: red/blue/black	P01103062
Bag	P01298066



ELECTRICAL TESTING AND SAFETY

Earth and resistivity testers



		CA 6460	CA 6462	CA 6470N	CA 6471
Reference		P01126501	P01126502	P01126506	P01126505
3P Method	Range	0.01 to 2,000 Ω		0.01 Ω to 99.99 kΩ	
	Resolution	10 mΩ/100 mΩ/1 Ω		0.01 to 100 Ω	
	Measurement frequency	128 Hz		41 to 513 Hz	
	Coupling measurement	Yes		Yes (Automatic)	
4P Method	Range	0.01 to 2,000 Ω		0.001 Ω to 99.99 kΩ	
	Resolution	10 mΩ/100 mΩ/1 Ω		0.001 to 100 Ω	
	4P Selective			Yes	
Earth measurement with 2 clamps	Range			0.01 to 500 Ω	
	Resolution	No		0.01 to 1 Ω	
	Measurement frequency			Auto: 1611 Hz Manual: 128 Hz, 1367 Hz, 1611 Hz, 1758 Hz	
Resistivity	Test method	Wenner and Schlumberger		Wenner and Schlumberger with automatic calculation	
	Range	0.01 to 2,000 kΩ		0.01 to 99.9 kΩ	
	Measurement frequency	128 Hz		41 to 128 Hz	
DC resistance measurement	Type of measurement			2 or 4 wires	
	Range	No		0.12 Ω / 0.020 Ω to 99.9 kΩ	0.12 Ω / 0.020 Ω to 99.9 kΩ
	Measurement current			> 200 mA DC	
Storage	No		512 memory locations		
Communication	No		Optically-isolated USB		
Dimensions / weight	273 x 247 x 127 mm / 2.8 kg / 3.3 kg		272 x 250 x 128 mm / 3 kg / 3.2 kg		
Safety	50 V CAT III, IEC 61010 & IEC 61557		50 V CAT IV, IEC 61010 & IEC 61557		
Power supply	8 x 1.5 V LR6 batteries		NiMH battery		

State at delivery

- **CA 6460** : delivered with 8 x 1.5 V LR6 batteries and 1 operating manual in 5 languages
- **CA 6462**: delivered with 1 mains lead for recharging and 1 operating manual in 5 languages
- **CA 6470N**: delivered with 1 external mains charger, data export software + optical / USB communication lead, 5 operating manuals (one per language) on CD-ROM, 5 simplified operating manuals, each in a different language, 5 descriptive labels, each in a different language
- **CA 6471**: delivered with 1 external mains charger, data export software + optical / USB communication lead, 2 C182 clamps with 2 safety leads, 5 operating manuals (one per language) on CD-ROM, 5 simplified operating manuals, each in a different language, 5 descriptive labels, each in a different language, 1 carrying bag.

Accessories

CA 6471

- MN82 clamp (diam. 20mm) (delivered with 1 x 2m cable for ES terminal connection) . . **P01120452**
- C182 clamp (diam. 20mm) (delivered with 1 x 2m cable for ES terminal connection) . . **P01120333**

Earth and resistivity kit (100 m kit)

Ref.: **P01102024**

Compartment bag with space for tester containing: 4 "T"-shaped rods, 4 coils of cable (100 m red, 100 m blue, 100m green, 30 m black), 1 green 10 m cable reeler, 1 mallet, 5 x Ø 4 mm lug/banana plug adapters



Standard 3P-method earth kit

50 m kit Ref.: P01102021

Carrying case containing: 2 "T"-shaped rods, 2 coils of cable (50 m red, 50 m blue), 1 green 10 m cable reeler, 1 mallet, 5 x Ø 4 mm lug/banana plug adapters

100 m kit Ref.: P01102022

Carrying case containing: 2 "T"-shaped rods, 2 coils of cable (100 m red, 100 m blue), 1 green 10 m cable reeler, 1 mallet, 5 x Ø 4 mm lug/banana plug adapters

For the CA 6471 and CA 6470N

- Dataview report generation software **P01102095**
- Adapter for recharging on vehicle cigarette lighter. **P01102036**
- Optical / RS communication cable **P01295252**
- GB mains power cable **P01295253**
- Set of 10 fuses - F 0.63 A - 250 V - 5x20 mm - 1.5 kA . . . **AT0094**
- Adapter for charging battery from the mains **P01102035**
- Battery pack **P01296021**
- Optical / USB communication cable. **HX0056-Z**

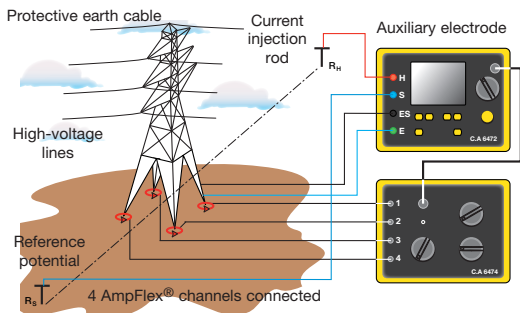

Earth and resistivity tester with adapter for pylon earth measurements

The CA 6472 can be used to carry out a quick but comprehensive survey of all earthing configurations. When used with the CA 6474 accessory, it allows users to measure the earth resistance of pylons.



	CA 6472	Accessory CA 6474
Reference	P01126504	P01126510
Specifications		
Measurements	Earth / Selective earth / Resistivity / Coupling / Continuity / Ground potential / Pylon earth (with CA 6474)	Overall pylon earth Earth resistance of each pylon footing Overall line impedance Quality of the protective earth cable connection
Type	Methods: 3P / 4P / 4P with clamp / 2 clamps	Active measurement (injection by CA 6472) Passive measurement (use of disturbance currents)
Measurement range	0.011 to 100 kΩ (automatic ranging)	
No-load voltage	16 V or 32 V (as required)	
Frequency	41 Hz to 5078 Hz	
Frequency sweep	Yes	
Auxiliary rod resistance measurement	Yes: 0.14 Ω to 100 kΩ	
U disturbance		
Measurement	0,00 to 65,0 V	
Noise rejection	Yes	
Power supply	Rechargeable NiMH battery	Powered by the CA 6472
Display	3 digital LCD screens	
Storage	512 storage locations	
Communication output	Optical / USB link	
Safety	IEC 61010 & IEC 61557	
Dimensions / weight	272 x 250 x 128 mm / 3.2 kg	272 x 250 x 128 mm / 2.3 kg

State at delivery

- **CA 6472:** delivered with mains adapter + 2P mains plug for battery recharging on mains, data export software + optical / USB communication cable, 2 x C182 clamps, 2 safety leads, 5 operating manuals (one per language) on CD-ROM, 5 simplified operating manuals (one per language), 5 identification labels (one per language), 1 bag.
- **CA 6474:** delivered with an accessories bag containing 1 connection cable, 6 BNC/BNC cables 15 m long, 4 flexible current sensors (AmpFlex®) 5 m long, 1 set of 12 identification rings for AmpFlex®, 2 cables (5 m green, 5 m black) with safety plugs on winder, 5 spade lug/Ø 4 mm banana plug adapters, 3 clamps, 1 calibration loop, 5 operating manuals and 5 specification labels, each in a different language.

Earth and Resistivity Kit (100m Kit)
see page 16



Accessories

CA 6472

- MN82 clamp (diam. 20mm) (delivered with 1 x 2m cable for ES terminal connection) . . . **P01120452**
- C182 clamp (diam. 20mm) (delivered with 1 x 2m cable for ES terminal connection) . . . **P01120333**

For the CA 6472 and CA 6474 :

- CA 6472 – CA 6474 connection cable **P01295271**
- 15 m BNC / BNC cable. **P01295272**
- 5 m AmpFlex® flexible current sensor for CA 6474. **P01120550**

- Set of 12 AmpFlex® identification rings **P01102045**
- Set of 3 adjustable clamps **P01102046**
- 5 m green cable for CA 6474 (E terminal connection) **P01295291**
- 5 m black cable for CA 6474 (ES terminal connection) **P01295292**
- Spade lug/Ø 4 mm banana plug adapters **P01102028**
- Calibration loop **P01295294**
- AmpFlex® flexible current sensors:
other lengths available on request



Earth clamps and loop testers

Discover the CA 6418 oblong-headed earth clamp



IP 40



	CA 6416	CA 6417	CA 6418
Reference	P01122015	P01122016	P01122018
Specifications			
Loop ohmmeter	Measurement ranges (Ω) / Resolution (Ω) / Accuracy		
	Display on 1,500 counts		Display on 1,200 counts
	0.010 to 0.099 / 0.001 / ±1.5 % ±0.01 Ω		0.010 to 0.099 / 0.001 ±1.5% R* ±0.01 Ω
	0.10 to 0.99 / 0.01 / ±1.5 % ±2 r		0.10 to 0.99 / 0.01 / ±1.5 % R ±2 r
	1.0 to 49.9 / 0.1 / ±1.5 % ±r		1.0 to 49.9 / 0.1 / ±1.5 % R ±2r
	50.0 to 99.5 / 0.5 / ±2 % ±r		50.0 to 149 / 1 / ±2.5 % R ±2r
	100 to 199 / 1 / ±3 % ±r		150 to 245 / 5 / ±5 % R ±2r
	200 to 395 / 5 / ±5 % ±r		250 to 440 / 10 / ±10 % R ±2r
	400 to 590 / 10 / ±10 % ±r		450 to 640 / 10 / ±15 % R ±2r
	600 to 1,150 / 50 / Approx. 20 %		650 to 1200 / 50 / ±20 % R ±2r
1,200 to 1,500 / 50 / Approx. 25 %			
Frequency	Measurement frequency 2,083 Hz / Translation frequency 50, 60, 128 or 2,083 Hz		Measurement frequency 2,083 Hz
Loop inductance measurement	Measurement ranges (μH) / Resolution / Accuracy		
	10 to 100 / 1 / ±5 % ±r		
100 to 500 / 1 / ±3 % ±r			
Contact voltage (calculation)	Measurement ranges (V) / Resolution (V)		
	0.1 to 4.9 / 0.1		
	5.0 to 49.5 / 0.5		
50.0 to 75.0 / 1			
Ammeter Measurement ranges (A) / Resolution (A) / Accuracy Display on 4,000 counts	0.200 to 0.999 mA / 1 μA / ±2 % ±50 μA		0.5 to 9.995 mA / 50 μA / ±2 % R ±200 μA
	1.000 to 2.990 mA – 3.00 to 9.99 mA / 10 μA / ±2 % ±50 μA		10.00 to 99.90 mA / 100 μA / ±2 % R ±r
	10.00 to 29.90 mA – 30.0 to 99.9 mA / 100 μA / ±2 % ±r		100.00 to 299.0 mA / 1 mA / ±2 % R ±r
	100.0 to 299.0 mA – 0.300 to 0.990 A / 1 mA / ±2 % ±r		0.300 to 2.990 A / 10 mA / ±2 % R ±r
	1.000 to 2.990 A – 3.00 to 39.99 A / 10 mA / ±2 % ±r		3.00 to 20.00 A / 100 mA / ±2 % ±r
Setup			
Modes	Standard or advanced		Standard
Alarms	Configurable on Z, V and A		Configurable on Z and I
Buzzer	Active		
HOLD	Manual or automatic PRE-HOLD		
Auto power-off	Active / Inactive		
General specifications			
Display	152-segment OLED. Active area 48 x 39 mm		
Max. clamping diameter	Ø 35 mm		ø 32 mm - LxH : 30 x 40 mm / 20 x 55 mm
Data storage	300 date-stamped measurements	2,000 date-stamped measurements	300 date-stamped measurements
Communication	Bluetooth class 2		
Power supply	4 x 1.5 V, LR6 (AA) alkaline batteries or 4 x Ni-MH batteries		
Battery life	1,440 x 30-second measurements	2,440 x 30-second measurements	
Calibration	Automatic at startup		
Electrical safety	IEC 61010 600 V CAT IV		CEI 61010 100 V CAT IV, 150 V CAT III
Ingress protection	IP40		
Dimensions	55 x 95 x 262 mm		56 x 106 x 300 mm
Weight	Approx. 935 g with batteries		Approx. 1.2 kg with batteries

R = Reading, r = resolution

State at delivery

- **CA 6416** : 1 clamp delivered in a carrying case with 4 x 1.5 V batteries, 1 CD-Rom containing the User's Manual in 5 languages, 1 wrist strap
- **CA 6417** : 1 clamp delivered in a carrying case with 4 x 1.5 V batteries, 1 CD-Rom containing the User's Manual in 5 languages and the GTT software with simplified driver, 1 wrist strap
- **CA 6418** : 1 clamp delivered in a carrying case with 4 x 1.5 V batteries, 1 CD-Rom containing the User's Manual in 5 languages, 1 wrist strap, 1 quick startup guide, 1 multilingual safety datasheet, 1 inspection certificate

Accessories

- CL1 calibration loop P01122301
- DataView P01102095
- Hard case P01298080
- Two foam inserts for CA 6418 Please contact us



Locate hidden cables

Locate hidden circuits!

Comprising a transmitter and a receiver, the LOCAT-N provides digital, visual and audio indication of the presence of cables or ducts so that you can follow them intuitively.

**300 V
CAT III**

Transmitter



Receiver



CA 6681 LOCAT-N	
Reference	P01141626
CA 6681E transmitter	
Screen	LCD screen with display of functions and bargraph
Output signal frequency	125 kHz
External voltage measurement range	12 to 600 V _{ACDC}
Functions	Digital coding of signals for easy signal identification, selection of transmission signal code, torch function
Power supply	9 V battery
Dimensions	190 x 89 x 42.5 mm
Weight	420 g with battery
Electrical safety	300 V CAT III
CA 6681R receiver	
Screen	Backlit LCD with display of functions and bargraph, transmission code, receiver and transmitter battery-charge status
Detection Depth	
> Single-pole application	0 to 2 m
> Two-pole application	0 to 0.5 m
> Simple looping line	Up to 2.5 m
Identification of mains voltage	Approximately 0 to 0.4 m
Functions	Automatic shutdown, automatic or manual adjustment of reception sensitivity, torch function
Power supply	6 x 1.5 V AAA batteries
Dimensions	241.5 x 78 x 38.5 mm
Weight	360 g with batteries

State at delivery

- **CA 6681 LOCAT-N:** delivered in a hard case with 1 set of red/black 4 mm isolated banana leads (straight male / elbowed male), 1 set of 2 crocodile clips, 1 stake for earthing, 1 x 9 V battery, 6 x 1.5 V AAA batteries, 1 measurement adapter for B22 socket (bayonet), 1 adapter for E14 socket (screw-in), 1 mains socket adapter and 1 operating manual in 5 languages.





TESTING AND ELECTRICAL SAFETY

Micro-ohmmeters

- > 4-wire measurement method
- > Test current up to 10 A
- > Resolution 0.1 to 1 $\mu\Omega$

IP 53 50 V CAT III



State at delivery

- **CA 6420** delivered with a bag, a set of 2 x 10 A Kelvin clamps with 3 m cable, 1 x 2P European mains power cable 1.8 m long, data export software, 1 optical / USB communication cable
- **CA 6255** delivered with a bag, a set of cables 3 m long terminated by Kelvin clamps, 2 m Euro mains power cable, CD-ROM containing the MOT (Micro-Ohmmeter Transfer) data transfer software, RS 232 communication cable, CD-ROM containing the user's manual in 9 languages.

	CA 6240	CA 6255
	<i>Low resistance measurement</i>	
Reference	P01143200	P01143221
Measurement method	4-wire measurement	
Resistance	5 $\mu\Omega$ to 400.0 Ω	1 $\mu\Omega$ to 2,500 Ω
Resolution	1 $\mu\Omega$	0.1 $\mu\Omega$
Accuracy	0.25 %	0.05 %
Current	10 mA to 10 A	1 mA to 10 A
Reversal of current direction	Yes	No but automatic compensation of stray currents
Measurement mode	Normal	Inductive, non-inductive, non-inductive with automatic tripping
Temperature compensation	No	Manual or with Pt 100 probe
Power supply	NiMH rechargeable battery	
Safety	IEC 61010-1 / Cat III 50 V	
Dimensions	270 x 250 x 180 mm	
Weight	4.5 kg	4.5 kg
Data storage	100 measurements	1,500 measurements

Accessories

Double 1 A test probes (x 2).....	P01102056
Mini Kelvin clamp (set of 2).....	P01101783



- > Constant test at 100 A and up to 120 s at 200 A
- > Test current up to 200 A
- > Resistance from 0.1 $\mu\Omega$ to 1 Ω
- > Safe measurements: Both Sides Grounded (BSG) method
- > Storage of up to 8,000 measurement results

IP 54 BSG

	CA 6292		
Reference	P01143300		
Test current	Programmable from 20 to 200 A		
Resistance	0.1 $\mu\Omega$ to 2 m Ω	2 to 200 m Ω	200 m Ω to 1 Ω
Resolution	0.1 $\mu\Omega$ (200 A max)	10 $\mu\Omega$ (25 A max to 200 m Ω)	1 m Ω (5 A max to 1 Ω)
Output voltage	10 VAC: 4.2 V @ 200 A / 220 VAC: 8.6 V @ 200 A		
Maximum load resistance	100 VAC: 20 m Ω @ 200 A / 220 VAC: 42 m Ω @ 200 A		
Measurement method	4 Kelvin-type connection terminals		
Test mode	Normal or Both Sides Grounded (BSG)		
Test duration	Adjustable from 5 to 120s @200 A / unlimited below 100 A		
Data storage	Up to 8,000 measurement results		
Interface	USB 2.0		
Software	DataView®		
Power supply	100 to 240 VAC – 50/60 Hz		
Dimensions	502 x 394 x 190 mm		
Weight	Approx. 13 kg		
Storage temperature	-10 °C to +70 °C		
Humidity	95% RH		
Protection	Protected against overvoltages, short-circuits and voltage surges on output terminals		
Ingress protection	IP54		
Electrical safety	IEC 61010-1		

Current measurement with the MR6292 clamp available as an option

	MR6292
Reference	P01120470
Measurement range	1.0 - 50.0 Aac
Resolution	0.1 mA
Intrinsic uncertainty	± (1.5% + 2 cts)
Output signal	10 mV / Adc
Load impedance	>100 k Ω // 100 pF
Influence of conductor position in jaws	0.50%

State at delivery

CA 6292 delivered with:
a case containing 1 set of 2 x 6 m Kelvin leads (red / black) with adjustable-clamp connections, 1 green earth cable 3m long with crocodile clip, 1 USB cable 1.5m long, 1 fuse T 15 A 250V mounted in the instrument, 1 European mains power cable, 1 user's manual in 5 languages on CD-ROM, 1 CD-ROM containing the DataView software.

Accessories / Replacement Parts

1 set of 2 x 15 m Kelvin leads (red / black) adjustable-clamp connections.....	P01295487
1 MR 6292 current clamp for CA 6292.....	P01120470
1 set of 2 x 6 m Kelvin leads (red / black) adjustable-clamp connections.....	P01295486
1 green earth cable with crocodile clip.....	P01295488
1 set of 5 fuses T 15A 250V 5x20mm.....	P01297101
1 USB-A USB-B cable 1.5m long.....	P01295293



Ratiometer

- > Transformation ratio measurement on power, voltage and current transformers
- > Storage of up to 10,000 measurement results

50 V
CAT IV

IP
53



DTR 8510

Digital ratiometer for transformers

Reference	P01143200	
Range of ratios (VT)	Automatic: 0.8000 to 8,000:1	
Accuracy (VT)	Range of ratios	Accuracy (% of reading)
	0.8000 to 9.9999	± 0.2 %
	10.000 to 999.99	± 0.1 %
	1000.0 to 4999.9	± 0.2 %
	5000.0 to 8000.0	± 0.25 %
Range of ratios (TC)	Autoranging: 0.8000 to 1000.0	
Accuracy (TC)	± 0.5 % of reading	
Excitation signal	VT mode: 32 Vrms max CT mode: Auto level 0 to 1 A, 0.1 to 4.5 Vrms	
Excitation current display	Range: 0 to 1,000 mA; Accuracy: ± (2 % R + 2 mA)	
Excitation frequency	70 Hz	
Display	Alphanumeric LCD, 2 lines of 16 characters with adjustment of contrast and backlighting. Easy to read in both daytime and nighttime conditions	
Available languages	French, English, Spanish, Italian, German, Portuguese	
Measurement method	According to IEEE Std C57, 12.90™ standard	
Power supply	Two rechargeable batteries: 12 V, NiMH, 1650 mAh	
Battery life	Up to 10 hrs in continuous operation, low-battery warning	
Battery charger	Universal input (90 to 264 Vrms), smart charger	
Charging time	< 4 hours for full charge	
Storage	10,000 tests	
Date / time	Power supplied by dedicated battery, real-time clock	
Communication	USB 2.0, optical isolation, 115.2 kB	
Software	Delivered with DataView® analytical software	
Dimensions / Weight	272 x 248 x 130 mm / 3.7 kg	
Connection	XLR connectors	
Leads	Screened H and X leads, length 4.6 m (15 ft), equipped with colour-coded crocodile clips	
Casing	Rugged polypropylene casing, UL 90 V0	
Vibrations	IEC 68-2-6 (1.5 mm at 55 Hz)	
Shocks	IEC 68-2-27 (30 G)	
Falls	IEC 68-2-32 (1 m)	
Protection rating	IP 40 with cover open as per EN 60529 IP 53 with cover closed as per EN 60529	
Safety	EN 61010-1, 50 V CAT IV; pollution degree 2	

State at delivery

DTR 8510 delivered with:

Delivered with a carrying bag containing 1 set of 4.6 m leads with crocodile clips, 1 external battery charger with mains power cable, 1 USB cable, 1 NiMH battery datasheet, 1 operating manual and DataView software on CD-Rom



POWER, ENERGY, DISTURBANCES

Power analysers for three-phase networks

QUALI *STAR+*

- > 5 voltage inputs & 4 current inputs
- > Inrush mode over 10 minutes
- > Calculation of distorting power



1000 V
CAT III

600 V
CAT IV

3U
4I

4U
4I

IP
53

CEI
61000-4-30

EN
50160

IP
67



	CA 8331 P01160511	CA 8333 P01160541	CA 8336 P01160591	CA 8436 P01160595
Reference	P01160511	P01160541	P01160591	P01160595
Number of channels		3U / 4I		4U / 4I
Number of inputs		4V / 3I		5V / 4I
IEC 61000-4-30			EN50160 reports	
Voltage (TRMS AC+DC)		2 V to 1,000 V		
Voltage ratio		Up to 500 kV		
Current (TRMS AC+DC)		MN93: 500 mA to 200 AAC ; MN93A: 0.005 AAC to 100 AAC		
MN clamps		1 A to 1,000 AAC		
C193 clamps		100 mA to 10,000 AAC		
AmpFlex® or MA clamps		1 A to 1,300 AAC/DC		
PAC93 clamp		50 mA to 100 AAC/DC		
E3N clamp				50 A to 3,500 AAC / 5,000 ADC
J93				
Current ratio		Up to 60 kA		
Frequency		40 Hz to 69 Hz		
Power		W (P), VA (S), var (N, Q ₁ , D), VAD, PF, DPF, cos φ, tan φ		W (P), VA (S), var (N, Q ₁ , D), PF, DPF, cos φ, tan φ
Energy		Wh, varh (Nh, Q ₁ h, Dh), VAh		
Harmonics		Yes		
THD		Yes, from 0 to 50th order, phase		
Expert mode			Yes	
Transients		50		210
Flicker (Pst and Plt)		Pst		Pst and Plt
Inrush mode		Yes on 4 periods		Yes > 10 minutes
Unbalance			Yes	
Recording		Yes		
Min/Max of a selection of parameters at max. sampling rate	4 hrs to 2 weeks	A few days to several weeks	2 weeks to several years	
Alarms		4,000 of 10 different types	10,000 of 40 different types	
Peak		Yes		
Vectorial representation		Automatic		
Display		Colour ¼ VGA TFT screen, 320 x 240, diagonal 148 mm		
Capture of screens and curves	12		50	
Electrical safety		IEC 61010 1 000 V CAT III / 600 V CAT IV		
Ingress protection		IP53 / IK08		IP67
Languages		More than 27		
Battery life		Up to 13 hours		
Communication interface		USB		
Power supply		9.6 V NiMH rechargeable battery or mains power supply		
EN50160 report		Yes, with DataView® software		
Dimensions - Weight		240 x 180 x 55 mm - 1.9 kg	270 x 250 x 180 mm / 3.7 kg	
Warranty		3 years		

State at delivery

• **CA 8336 • CA 8333 - CA 8331 - Models without sensors:** Qualistar+ analyser delivered with a bag for accessories, 5 voltage cables 3 m long with 4 mm banana connections, 5 crocodile clips, a set of 12 coloured elements for identifying cables and inputs, an anti-scratch film to protect the screen (mounted), a USB cable, a mains power pack, a safety datasheet, a CD containing a multilingual user's manual and a CD containing the PC data retrieval software (Power Analyser Transfer).

• **CA 8436** - 1 bag No. 22, 1 IP67 mains cable, 1 USB cable, 5 x 4 mm banana voltage cables 3 m long, 5 crocodile clips, 1 set of colour-coded rings/inserts for identifying the cables and inputs, 1 anti-scratch screen-protection film (mounted), 1 safety datasheet, 1 CD-ROM containing the Power Analyser Transfer PC data recovery software.



Software

The measurements performed with the Qualistar models can be processed using two software products:

Power Analyzer Transfer (standard) and **DataView**® (option).

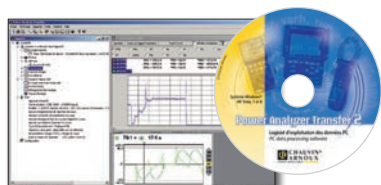

Power Analyzer Transfer

For transferring data onto a PC and communicating in real time via USB.

Supplied with the Qualistar+ models

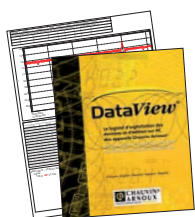

DataView®

Powerful configuration, transfer and measurement data processing software, with generation of reports according to the voltage quality standards as well as **EN5010** reports (CA 8333/8230)

DataView® is compatible with other Chauvin Arnoux® products:

- CA 8220 & CA 8230 power analysers
- F407 and F607 multimeter clamps
- and other measuring instruments

Minimum required operating system: Windows® 7, 8 and 10.

Reference	P01102095
-----------	-----------

Complementary accessories

E3N adapter	P01102081
E3N mains power pack	P01120047
Battery pack	P01296024
Qualistar screen film	P01102059
Set of inserts and rings	P01102080
Set of 5 IP67 banana leads 3 m long (BB196)	P01295479
Bag no. 21	P01298055
Bag no. 22	P01298056
USB-A USB-B lead 1.5 m long	P01295293
5 A casing	P01101959
Lockable crocodile clips (x 5)	P01102099
Kit comprising banana leads (x 5), crocodile clips (x 5) and a set of coloured rings	P01295483
Kit comprising banana leads (x 4), crocodile clips (x 4) and a set of coloured rings	P01295476
Set of plugs (CA 8436)	P01102147
Mains power pack (CA 8436)	P01102057

Accessories for all Qualistar+ models

Mains adapter

PA31ER adapter for 1,000 V power supply via the phase



Reference	P01102150
-----------	-----------

Storage tool

Reeling Box winder for stowing measurement cables



Reference	P01102149
-----------	-----------

Clamps for Qualistar+



	MA193 -250	MA193 -350	MA196 -350	A193 -450	A193 -800	A196 -450
Reference	P01120580	P01120567	P01120568	P01120526B	P01120531B	P01120554
Indice IP67	-	-	yes	-	-	yes
Measurement range	100 mA to 10 kAac					
Clamping Ø / length	Ø 70 mm / 250 mm	Ø 100 mm / 350 mm	Ø 100 mm / 350 mm	Ø 140 mm / 450 mm	Ø 250 mm / 800 mm	Ø 190 mm / 610 mm
IEC 61010	1,000 V CAT III / 600 V CAT IV					1,000 V CAT IV



	MN93	MN 93A	PAC93	C193	E3N	J93
Reference	P01120425B	P01120434B	P01120079B	P01120323B	P01120043A	P01120110
Measurement range	500 mA to 200 AAC	0,005 AAC to 100 AAC	1 A to 1,000 AAC 1 A to 1,300 ADc	1 A to 1,000 AAC	50 mA to 100 AAC/dc 100 mA to 100 AAC/dc	50 to 3,500 AAC 50 to 5,000 ADc
Clamping Ø	20 mm		1 x Ø 39 mm 2 x Ø 25 mm	52 mm	11.8 mm	72 mm
IEC 61010	600 V CAT III / 300 V CAT IV		600 V CAT III / 300 V CAT IV	600 V CAT IV	600 V CAT III / 300 V CAT IV	600 V CAT IV / 1,000 V CAT III



POWER, ENERGY, DISTURBANCES

Power and Energy Loggers

- > Single-phase, split-phase and three-phase installations
- > Installation without cutting off the mains power supply
- > Bluetooth, Ethernet and USB Communication
- > Automatic recognition of the sensors connected
- > Recording on SD card

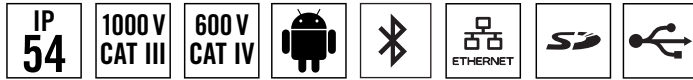

	PEL102 P01157152	PEL103 P01157153
Standard reference	P01157152	P01157153
Reference with 3 MA 193 current sensors	P01157150	P01157151
Display	Without	With triple digital display
Installation types	Single-phase, split-phase, three-phase with or without neutral, and many other specific configurations	
Number of channels	3 Voltage inputs / 3 Current inputs (neutral current calculated)	
Measurements		
Network frequency	DC, 50 Hz, 60 Hz & 400 Hz	
Voltage (Measurement ranges/ Best accuracy)	10.00 to 1000 V _{AC/DC} / +/- 0.2 % + 0.5 V	
Current (depending on sensors) (measurement ranges / best accuracy)	from 5 mA _{AC} to 10 kA _{AC} / 50 mA _{DC} to 1,4 kA _{DC} / ±0.5 %	
Calculated measurements		
Ratios	Up to 650,000 V / up to 25,000 A	
Power	10 W to 10 GW / 10 var to 10 Gvar / 10 VA to 10 GVA	
Energy	Up to 4 EWh / 4 EVAh / 4 Evarh (E = 1018)	
Phase	cos φ, tan φ, PF	
Harmonics	Up to 50th order	
Additional functions		
Phase order	Yes	
Min / Max	Yes	
Mounting	Magnet, hook	
Recording		
Sampling / Acquisition rate / Aggregation	128 samples/period - 1 measurement/s – from 1 min to 60 min	
Storage	SD Card, 8 GB (SD-HC Card up to 32 GB)	
Communication	Ethernet & Bluetooth	
Power supply	110 V - 250 V (+10 %, -15 %) @ 50-60 Hz & 400 Hz	
Safety	IEC 61010 600 V CAT IV – 1,000 V CAT III	
Mechanical specifications		
Dimensions	256 x 125 x 37 mm without sensor	
Weight	900 g	950 g
Casing	IP54, ETL	

Accessories

DataVIEW® software	P01102095
Bag No 23	P01298078
Leads/clamps kit	P01295476
Set of id. rings/inserts	P01102080
5 A box	P01101959
PEL100 mains adapter	P01102134
Mains power cable	P01295174
Reeling Box	P01102149

State at delivery

- **PEL102** and **PEL103**: 4 measurement leads (straight banana / straight banana – 3 m long – black), 4 crocodile clips (black), 1 SD card (8 GB), 1 set of rings and inserts (for ends of leads and current sensors), 1 mains cable, 1 USB cable (Type A / Type B), 1 operating manual (on CD), 1 bag, 1 safety datasheet, PEL Transfer PC software, 1 quick start-up guide, 1 SD MN adapter (depending on model).



PEL100 mains adapter
To self-power the PEL via the voltage measurement channel

Clamps for PEL



	MA193 -250	MA193 -350	MA196 -350	A193 -450	A193 -800	A196 -450
Reference	P01120580	P01120567	P01120568	P01120526B	P01120531B	P01120554
Indice IP67	-	-	yes	-	-	yes
Measurement range	200 mA to 10 kA _{AC}					
Clamping Ø / length	Ø 70 mm / 250 mm	Ø 100 mm / 350 mm	Ø 100 mm / 350 mm	Ø 140 mm / 450 mm	Ø 250 mm / 800 mm	Ø 190 mm / 610 mm
IEC 61010	1,000 V CAT III / 600 V CAT IV					1,000 V CAT IV



	MN93	MN 93A	PAC93	C193	E3N	J93
Reference	P01120425B	P01120434B	P01120079B	P01120323B	P01120043A	P01120110
Measurement range	500 mA to 200 A _{AC}	0,005 A _{AC} to 100 A _{AC}	1 A to 1,000 A _{AC} 1 A to 1,300 A _{DC}	1 A to 1,000 A _{AC}	50 mA to 10 A _{AC/DC} 100 mA to 100 A _{AC/DC}	50 to 3,500 A _{AC} 50 to 5,000 A _{DC}
Clamping Ø	20 mm		1 x Ø 39 mm 2 x Ø 25 mm	52 mm	11.8 mm	72 mm
IEC 61010	600 V CAT III / 300 V CAT IV		600 V CAT III / 300 V CAT IV	600 V CAT IV	600 V CAT III / 300 V CAT IV	600 V CAT IV / 1,000 V CAT III

Power and energy logger

- > Ideal for mounting on electricity poles
- > All-terrain shockproof casing resistant to UV light and high temperatures
- > Self-powered by its voltage inputs up to 1,000 V
- > Continuous recording at 200 ms intervals
- > Measurements in compliance with IEEE 1459



	PEL 105 P01157155
Reference	P01157155
Display	With backlit triple digital display
Type of installation	Single-phase, split-phase, three-phase with or without neutral and many other specific configurations
Number of inputs	5 voltage inputs, 4 current inputs
Number of channels	4 voltage channels, 4 current channels
Measurements	
Network frequency	DC, 50 Hz, 60 Hz and 400 Hz
Voltage (measurement ranges / best accuracy)	10.00 V to 1,000 VAC @ 50/60 Hz, or 600 VAC @ 400 Hz / 1,000 VDC
Current (depending on sensors) (measurement ranges / best accuracy)	5 mAAC to 10 kAAC / 50 mADC to 1.4 kADC
Calculated measurements	
Ratio	Up to 650,000 V / up to 25,000 A
Power	20 W to 10 GW / 20 var to 10 Gvar / 20 VA to 10 GVA
Energy	Up to 4 EWh / 4 EVAh / 4 Evarh (E = 1018)
Phase	cos ϕ , tan ϕ , PF
Phase sequence	Automatic selection of the phase sequence
Harmonics	Up to the 50th order
Additional functions	
Phase sequence	Indication of valid connection
Min / Max	On all quantities
Recording	
Sampling rate/ Acquisition rate / Aggregation	128 samples/period - 5 measurements/s - from 1 min to 1 hr
Storage	SD card, 8 GB (up to 32 GB with SD-HC card)
Communication	Ethernet, Bluetooth, Wifi and USB
Power supply	Self-powered internally from 94 to 1,000 V @ 50-60 Hz & 400 Hz / DC
Safety	IEC 61010 1,000 V CAT IV
Mechanical specifications	
Dimensions	245 x 270 x 180 mm
Weight	< 4 kg
Protection	IP 67

Clamps for PEL

see page 26

Reeling Box

for stowing the measurement leads of your PEL



Reference	P01102149
------------------	------------------

State at delivery

PEL 105 delivered with:

- 5 x 3 m black silicone cables, straight banana / straight banana, 5 black 1,000 V CAT IV crocodile clips, 1 set of inserts/rings, 4 AmpFLEX® IP67 A196 3 m long, 1 set of waterproof plugs, 1 SD card, 1 USB cable, 1 bag, 1 safety datasheet, USB key containing 1 quick start-up guide and 1 user manual.

Accessories

Clamps for PEL - see page 24

Set of waterproof plugs	P01102147
Pole-mounting kit	P01102146
DataView® software	P01102095
Crocodile clips kit (x 5)	P01102099
Set of inserts/rings	P01102080
5 A adapter	P01101959
Leads kit (x 5) BB196	P01295479
Reeling Box	P01102149
E3N adapter	P01102081
PA30 mains power pack	P01102057



PORTABLE OSCILLOSCOPES

Portable oscilloscopes with isolated channels

600 V
CAT III

IP
54



	OX 5022	OX 5042
Bandwidth	20 and 40 MHz	
Channels (number / type)	2 isolated	
IEC61010 safety	1 000V CAT II - 600V CAT III	
Analogue display or equivalent	No	
One-shot digital sampling rate	50 MS/s	
Repetitive mode	2 GS/s	
Vertical resolution	9 bits	
Transient detection (Glitch)	> 20ns	
Scaling / physical unit	•/•	
PC communication / Ethernet USB	•	
Mains power supply / Battery	•/•	
Integrated mode	Harmonics and multimeter	
"Oscilloscope" specifications		
Max. input sensitivity	5 mV/div	
Max. input amplitude	200 V/div	
Analogue filter	1.5 MHz, 5 kHz	
Time base (per division)	25 ns - 200 s	
Roll mode / XY mode	•/•	
Memory depth	2.5 k/channel	
Acquisition memory	2 MB memory	
No. of reference or math curves on screen	2	
Envelope / Averaging modes	•/•	
SPO (Smart Persistence Oscilloscope)	-	
Automatic measurements / cursors	19/•	
Calculation functions: + - / x / : / Advanced	•/•/•	
Autoset with channel selection	•	
Other functions		
TRMS multimeters	50 kHz	
Harmonic analysis	31 orders	
Threshold recorders (number of channels)	2	
Measurement of power / power harmonics	•	
General specifications		
Colour screen	3.5"	



State at delivery

Version C: 1 oscilloscope delivered with 1 probe (1/10, 1000 V), 1 BNC/Banana adapter, 1 set of banana leads, 1 mains adapter, 1 set of 6 AA NiMH batteries, 1 "hands-free" bag, 1 CD-Rom containing 1 operating manual and 1 programming manual

Version CK: same as version C plus 1 optical USB communication cable and 1 CD containing the SX-METRO/P software and USB cable drivers

References

- OX5022-C:** 1 oscilloscope 2 x 20 MHz
- OX5022-CK:** 1 oscilloscope, 2 x 20 MHz + USB communication
- OX5042-C:** 1 oscilloscope 2 x 40 MHz
- OX5042-CK:** 1 oscilloscope 2 x 40 MHz + USB communication

On-site oscilloscopes with isolated channels

Scopix IV - 5 instruments in 1:

- > oscilloscope
- > FFT
- > multimeter
- > logger & harmonic analyser
- > wattmeter

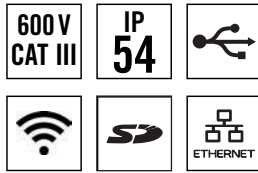

Scan this code

To find out more about the Scopix® offering:



Scopix bus - OX9302-BUS:

- > 2 isolated channels, 300 MHz bandwidth
- > For physical integrity tests on field buses

	OX9302-BUS	OX9304	OX9104 / OX9102	OX9062
Family	Field buses	Electronics	Electricity	Industry
References	OX9302-BUS	OX9304	OX9104 / OX9102	OX9062
Bandwidth	300 MHz	300 MHz	100 MHz	60 MHz
Channels (number/type)	2 isolated	4 isolated	2 or 4 / isolated	2 / isolated
IEC61010 safety	CATII 1000V/CATIII 600V			
One-shot digital sampling	2.5 GS/s	2.5 GS/s	2.5 GS/s	2.5 GS/s
Max. sampling rate in repetitive mode	100 GS/s	100 GS/s	100 GS/s	100 GS/s
Vertical resolution	12 bits	12 bits	12 bits	12 bits
Scaling/physical unit	•/•	•/•	•/•	•/•
PC communication via Ethernet/Wifi	•/-	•/•	•/•	•/•
ScopeNet PC web server	•	•	•	•
Ni-MH/LI-ION battery	•/-	-/•	-/•	-/•
"Oscilloscope" specifications				
Min. input sensitivity	156 µV/div	156 µV/div	156 µV/div	156 µV/div
Max. input amplitude	200 V/div	200 V/div	200 V/div	200 V/div
Analogue filters	15 MHz, 1.5 MHz, 5 kHz	15 MHz, 1.5 MHz, 5 kHz	15 MHz, 1.5 MHz, 5 kHz	15 MHz, 1.5 MHz, 5 kHz
Time base (per division)	1 ns-200 s	1 ns-200 s	1 ns-200 s	1 ns-200 s
Roll mode / XY mode	•/•	•/•	•/•	•/•
Memory depth	100 k / channel	100 k / channel	100 k / channel	100 k / channel
Acquisition memory	> 2 GB on SD Card (all formats)	> 2 GB on SD Card (all formats)	> 2 GB on SD Card (all formats)	> 2 GB on SD Card (all formats)
No. of reference curves or math curves on screen	4	4	4	4
Automatic measurements/Cursors	20/•			
Pulse triggering width/number	•/•	•/•	•/•	•/•
Hold-Off / adjustable delay	•/•	•/•	•/•	•/•
+ - / x / : / advanced calculation functions	•/•/•/•	•/•/•/•	•/•/•/•	•/•/•/•
Autoset with channel selection	•	•	•	•
Other functions				
Spectral analysis, FFT Lin & Log	112 bits / 72 dB+ waveform	12 bits / 72 dB+ waveform	12 bits / 72 dB+ waveform	12 bits / 72 dB+ waveform
TRMS multimeters	200 kHz	200 kHz	200 kHz	200 kHz
Logger	Recording in MULTIMETER mode, file: 100 kpts			
Harmonic analysis	63 orders	63 orders	63 orders	63 orders
Threshold loggers (number of channels)	2	4	2 or 4	2
Power / Power Harmonics measurement	•/-	•/-	•/-	•/-
General specifications				
LCD colour screen 5.7/7/3.5"	7"	7"	7"	7"
Soft calibration with 100% "closed casing"	•	•	•	•

State at delivery SCOPIX IV

1 SCOPIX IV oscilloscope delivered in a carrying bag, 1 PA40W-2 power pack / charger and one 2P EURO mains cable, 1 Li-Ion battery pack, 1 stylus, 1 Ethernet cable, 1 USB cable, 2 safety cables (red, black), 2 x Ø 4 mm test probes (red, black), 2 or 4 voltage probes depending on models, 1 µSD card (8 GB), 1 USB/ µSD adapter, 1 hand strap, 1 PROBIX BANANA, 1 USB installation procedure for use of the ScopeNet data export software on CD-ROM, 1 pdf User's Manual on CD (>5 languages), 1 startup guide on paper and 1 safety datasheet in 20 languages.

State at delivery SCOPIX BUS

SCOPIX BUS delivered in a bag with 1 mains adapter/charger, 1 LI-ION battery pack, 1 stylus, 2 x 1/10 ProbiX HX0130 probes, 1 x Ø4 mm ProbiX banana adapter, 1 set of cables + Ø4 mm banana test probe, 1 Ethernet cable, 1 USB cable, 1 µSd card (8 GB) with SD Card adapter, HX0190 and HX0191 bus connection boards, 1 CD-Rom containing the User's Manual, Programming Manual and SX-BUS 2.0 software.









CURRENT MEASUREMENT

Scan this code for further information about the clamps:

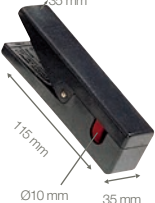
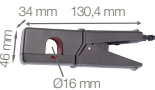

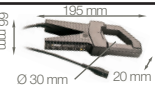
AC and AC/DC current measurement





	Series	Model	Input ⁽¹⁾					Output / Connections				Specific features					To order					
			Very low current	Low current	Medium current	High current	~ AC	DC	Current	Voltage	Leads + safety plug ø 4 mm ⁽²⁾	Female sockets ø 4 mm	BNC connector (oscilloscope)	Transformation ratio (input/output)	Output protected against overvoltage	Automatic DC zero		Power measurement (low phase shift)	Bandwidth (frequency in Hz)	Typical accuracy		
AC	 <p>35 mm 115 mm Ø10 mm 35 mm</p>	MINI 01		2 to 150 A			●		0.15 A AC			●		1,000/1	●			48 Hz... 500 Hz	≤ 2.5 %	P01051101Z		
		MINI 02	50 mA to 100 A				●		0.1 A AC			●		1,000/1	●	●		48 Hz... 10 kHz	≤ 1 %	P01051102Z		
		MINI 03		1 to 100 A				●		0.1 V AC			●		1 A / 1 mV				≤ 2 %	P01051103Z		
		MINI 05		5 mA to 10 A 1 to 100 A				●		10 V A AC 0.1 V AC			●		1 mA/1 mV 1 A/1 mV			48 Hz... 500 Hz	≤ 3 % ≤ 2 %	P01051105Z		
		MINI 09		1 to 150 A				●		15 V DC			●		1 A/100 mV				≤ 4 %	P01051109Z		
	 <p>34 mm 130.4 mm 46 mm Ø16 mm</p>	MINI 102		0.05 A - 200 A				●		0.2 A ac			●		1,000/1				48 Hz... 10 kHz	≤ 1 %	P01106102	
		MINI 103		0.1 A - 200 A				●		0.2 V AC			●		1 A / 1 mV				48 Hz... 10 kHz	≤ 1.5 %	P01106103	
	 <p>18.5 mm Ø21 mm 136 mm 57 mm</p>	MN08		0.5 to 240 A				●		0.2 A AC			●		1,000/1				40 Hz... 10 kHz	≤ 1 %	P01120401	
		MN09		0.5 to 240 A				●		0.2 A AC			●		1,000/1				40 Hz... 10 kHz	≤ 1 %	P01120402	
		MN11		0.5 to 240 A				●		0.2 A AC			●		1,000/1	●			40 Hz... 10 kHz	≤ 2 %	P01120404	
		MN12		0.5 to 240 A				●		2 V AC			●		1 A/10 mV				40 Hz... 10 kHz	≤ 1 %	P01120405	
		MN13		0.5 to 240 A				●		2 V AC			●		1 A/10 mV				40 Hz... 10 kHz	≤ 1 %	P01120406	
		MN14		0.5 to 240 A				●		0.2 V AC			●		1 A/1 mV				40 Hz... 10 kHz	≤ 1 %	P01120416	
		MN39		0.1 to 24 A 0.5 to 240 A				●		2 V AC 2 V AC			●		1 A/100 mV 1 A/10 mV				40 Hz... 10 kHz	≤ 1 %	P01120408	
		MN73		10 mA to 2.4 A 100 mA to 240 A				●		2 V AC 2 V AC			●		1 mA/1 mV 1 A/10 mV				40 Hz... 10 kHz	≤ 1 % ≤ 2 %	P01120421	
		MN89		0.5 to 240 A				●		20 V DC ⁽³⁾			●		1 A/100 mV				40 Hz... 10 kHz	≤ 2 %	P01120415	
	 <p>135 mm Ø30 mm 20 mm</p>	Y1N		4 A to 600 A				●		0.5 A AC			●		1,000/1	●			48 Hz... 1 kHz	≤ 3 %	P01120001A	
		 <p>Ø101 mm 216 mm 31 mm 99 mm</p>	C100		0.1 A to 1,200 A				●		1 A AC			●		1,000/1				30 Hz... 10 kHz	≤ 0.5 %	P01120301
			C103		0.1 A to 1,200 A				●		1 A AC			●		1,000/1	●			30 Hz... 10 kHz	≤ 0.5 %	P01120303
C122				1 A to 1,200 A				●		5 A AC			●		1,000/5	●			30 Hz... 10 kHz	≤ 1 %	P01120306	
C148				1 to 300 A 1 to 600 A 1 to 1,200 A				●		5 A AC			●		250/5 500/5 1,000/5	●			48 Hz... 1 kHz	≤ 2 % ≤ 1 % ≤ 1 %	P01120307	
C173				1 mA to 1.2 A 0.01 to 12 A 0.1 to 120 A 1 to 1,200 A				●		1 V AC			●		1 A/1 V 10 A/1 V 100 A/1 V 1,000 A/1 V				10 Hz... 3 kHz	≤ 0.7 % ≤ 0.5 % ≤ 0.3 % ≤ 0.2 %	P01120309	
 <p>49 mm Ø64 mm 310 mm 310 mm</p>	D30CN		1 to 3,600 A				●		1 A AC			●		3,000/1	●	●		30 Hz... 5 kHz	≤ 0.5 %	P01120064		
	D36N		1 to 3,600 A				●		3 A AC			●		3,000/3	●	●		30 Hz... 5 kHz	≤ 0.5 %	P01120055A		
AC/DC	 <p>11 mm 15 mm Ø3,9 mm 25 mm</p>	K1		1 mA to 4.5 A DC 1 mA to 3 A RMS 1 mA to 4.5 A peak			●	●		4.5 V DC 3 V RMS 4.5 V peak			●					DC... 2 kHz	≤ 1 %	P01120067A		
		K2		100 µA to 450 mA DC 100 µA to 300 mA RMS 100 µA to 450 A peak			●	●		4.5 V DC 3 V RMS 4.5 V peak			●						DC... 1.5 kHz	≤ 1 %	P01120074A	
	 <p>67 mm 231 mm Ø11,8 mm 20 mm</p>	E1N		0.05 to 2 A DC 0.05 to 1.5 A AC 0.5 to 150 A AC/DC			●	●		2 V DC 1.5 V AC 150 mV AC/DC			●						DC... 2 kHz DC... 8 kHz	≤ 2 % ≤ 1.5 %	P01120030A	
		E6N		5 mA to 2 A DC 5 mA to 1.5 A AC 20 mA to 80 A AC/DC			●	●		2 V AC 1.5 V AC 0.8 V AC/DC			●							DC... 2 kHz DC... 8 kHz	≤ 2 % ≤ 4 %	P01120040A

(1) The higher value corresponds to 120% of the max. rated value (2) Reshaping of AC signal by diodes (3) Lead + electronic unit with Ø 4 mm safety plugs, 19 mm spacing, for K series

AC/DC current measurement



AC/DC

Series	Model	Input ⁽¹⁾						Output / Connections					Specific features					To order
		Very low current	Low current	Medium current	High current	~ AC	DC	Current	Voltage	Cables + ø 4 mm safety plug	ø 4 mm female sockets	BNC connector (oscilloscope)	Transformation ratio (input/output)	Output protected against overvoltages	Automatic zero DC	Power measurements (low phase shift)	Bandwidth (frequency in Hz)	
	PAC15	0.5 to 400 A AC 0.5 to 600 A DC						600 mV AC/DC				1 A/1 mV				DC... 30 kHz	≤ 2 %	P01120115
	PAC16	0.5 to 40 A AC 0.5 to 60 A DC 0.5 to 400 A AC 0.5 to 600 A DC						600 mV AC/DC 600 mV AC/DC				1 A/10 mV 1 A/1 mV				DC... 30 kHz	≤ 1.5 % ≤ 2 %	P01120116
	PAC17	0.5 to 40 A AC 0.5 to 60 A DC 0.5 to 400 A AC 0.5 to 600 A DC						600 mV peak 600 mV peak				1 A/10 mV 1 A/1 mV				DC... 30 kHz	≤ 1.5 % ≤ 2 %	P01120117
	PAC25	0.5 to 1000 A AC 0.5 to 1400 A DC						1.4 V AC/DC				1 A/10 mV				DC... 30 kHz	≤ 4 %	P01120125
	PAC26	0.5 to 100 A AC 0.5 to 150 A DC 0.5 to 1000 A AC 0.5 to 1400 A DC						1.5 V AC/DC 1.4 V AC/DC				1 A/10 mV 1 A/1 mV				DC... 30 kHz	≤ 1.5 % ≤ 4 %	P01120126
	PAC27	0.5 to 100 A AC 0.5 to 150 A DC 0.5 to 1000 A AC 0.5 to 1400 A DC						1.5 V peak 1.4 V peak				1 A/10 mV 1 A/1 mV				DC... 30 kHz	≤ 1.5 % ≤ 4 %	P01120127

Measurement on oscilloscope

Series	Model	Input						Output / Connections					Specific features					To order		
		Measurement range ⁽¹⁾						Current	Voltage	Leads + safety plug ø 4 mm ⁽²⁾	Female sockets ø 4 mm	BNC connector (oscilloscope)	Transformation ratio (input/output)	Output protected against overvoltage	Automatic DC zero	Power measurement (low phase shift)	Bandwidth (frequency in Hz)		Typical accuracy	
AC	MN60	0.1 A to 60 A peak 0.5 A to 600 A peak						6 V peak				1 A / 100 mV 1 A / 10 mV					40 Hz to 40 kHz	≤ 2 % ≤ 1.5 %	P01120409	
	Y7N	1 A to 1,200 A peak						1.2 V peak				1 mA / 1 mV					5 Hz to 10 kHz	≤ 2 %	P01120075	
	C160	0.1 A to 30 A peak 1 A to 300 A peak 1 A to 2,000 A peak						3 V peak 3 V peak 2 V peak				10 A / 1 V 100 A / 1 V 1000 A / 1 V					10 Hz to 100 kHz	≤ 3 % ≤ 2 % ≤ 1 %	P01120308	
	D38N	1 A to 90 A peak 1 A to 900 A peak 1 A to 9,000 A peak						10 V A AC 0.1 V AC				1 A / 10 V 1 A / 1 mV 1 A / 0.1 mV					30 Hz to 50 kHz	≤ 2 %	P01120057A	
	MA 200	MA200 30-300/3 (17 cm)	0.5 A ... 45 A peak 0.5 A ... 450 A peak						4.5 V peak				100 mV/A 10 mV/A					5 Hz to 1 MHz phase shift at 1 kHz ≤ 1.5°	≤ 1 % + 0.3 A	P01120570
		MA200 30-300/3 (25 cm)	0.5 A ... 45 A peak 0.5 A ... 450 A peak						4.5 V peak				100 mV/A 10 mV/A					5 Hz to 1 MHz phase shift at 1 kHz ≤ 1.5°	≤ 1 % + 0.3 A	P01120571
MA200 30-300/3 (35 cm)		5 A ... 4,500 A peak						4.5 V peak				1 mV/A					5 Hz to 1 MHz phase shift at 1 kHz ≤ 1.5°	≤ 1 % + 0.3 A	P01120572	
AC/DC	E3N	0.05 A to 10 A peak 1 A to 100 A peak						1 V peak				1 A / 10 mV 1 A / 1 mV					DC to 100 kHz	≤ 3 % ≤ 4 %	P01120043A	
	MH60	0.01 A - 140A peak						0.01 A - 140A peak				10 mV/A					DC to 1 MHz	≤ 1.5 %	P01120612	

(1) The higher value corresponds to 120 % of the max. rated value (2) Lead + electronic unit with Ø 4 mm safety plugs with 19 mm spacing for the AmpFLEX series



CURRENT MEASUREMENT

AC current measurement

MA400D, MA4000D

600 V CAT IV	TRMS	20 mA	MAX Hold
-----------------	------	-------	-------------

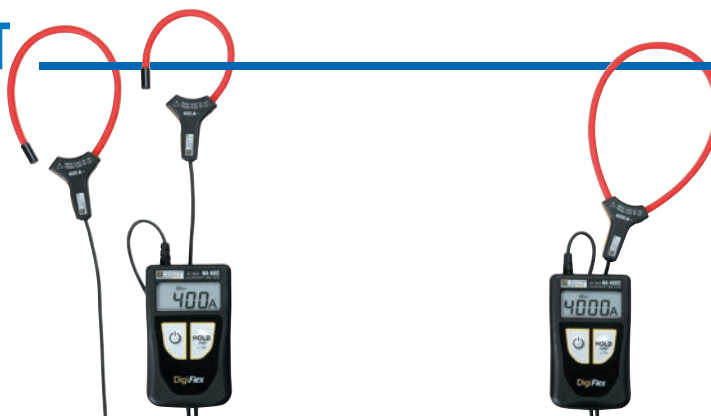

	MA400D-170 / MA400D-250			MA4000D-350		
References	P01120575Z / P01120567Z			P01120577Z		
Display range	4 A AC	40 A AC	400 A AC	40 A AC	400 A AC	4,000 A AC
Measurement range	0.020 A... 3.999 A	4.00 A... 39.99 A	40.0 A... 399.9 A	0.01 A... 39.99 A	40.0 A... 399.9 A	400 A... 3,999 A
Resolution	1 mA	10 mA	100 mA	10 mA	100 mA	1 A
Accuracy	± (2 % + 10 cts)	± (1.5 % + 2 cts)	± (1.5 % + 2 cts)	± (2 % + 10 cts)	± (1.5 % + 2 cts)	± (1.5 % + 2 cts)
Sensor clamping diam. / length	MA400D-170: Ø 45 mm / 170 mm MA400D-250: Ø 70 mm / 250 mm			MA4000D-350: Ø 100 mm / 350 mm		
Bandwidth	10 Hz ... 3 kHz					
Power supply	2 x 1.5 V AAA/LR3 batteries					
Safety	IEC 61010 CAT IV 600V					
Operating temperature	0°C to +50°C					
Instrument weight	Approx. 130 g					
Casing dimensions	100 x 60 x 20 mm					
Length of connection cable	0.8 m					

State at Delivery

1 DigiFLEX sensor delivered in a blister pack with 2 x 1.5V AAA batteries,
1 elastic strap and an operating manual in 5 languages

Accessories & Replacement Parts

Bag 120 x 200 x 60	P01298074
MULTIFIX accessories	P01102100Z
Elastic strap	P01102113

AmpFlex® flexible probes for AC current

1000 V CAT IV	80 mA	30000 A AC	IP 67	4 calibres
------------------	-------	------------	----------	---------------

Other dimensions:
contact us

Series	Model	Input						Output - Connections				Specific features					Reference	
		Very low current	Low current	Medium current	High current	Alternating current	Direct current	Current	Voltage	Lead + safety sockets ø 4 mm	Female sockets ø 4 mm	BNC connector (coaxial)	Transformation ratio (input/output)	Output protected against overvoltages	Automatic DC zero	Power measurement (low phase shift)		Bandwidth (frequency in Hz)
A110, A130	A110 3-30-300-3000/3 (45 cm / Ø 14 cm)	0.08 A - 3 A 0.5 A .. 30 A 0.5 A .. 300 A 0.5 A .. 3,000 A						3 V AC				1 V/A 100 mV/A 10 mV/A 1 mV/A				10 Hz .. 10 kHz 10 Hz .. 20 kHz 10 Hz .. 20 kHz 10 Hz .. 20 kHz	≤ 1%	P01120630
	A110 3-30-300-3000/3 (80 cm / Ø 25 cm)	0.08 A - 3 A 0.5 A .. 30 A 0.5 A .. 300 A 0.5 A .. 3,000 A						3 V AC				1 V/A 100 mV/A 10 mV/A 1 mV/A				10 Hz .. 10 kHz 10 Hz .. 20 kHz 10 Hz .. 20 kHz 10 Hz .. 20 kHz	≤ 1%	P01120631
	A110 30-300-3000-30000/3 (120 cm / Ø 38 cm)	0.05 A - 30 A 0.5 A .. 300 A 0.5 A .. 3000 A 0.5 A .. 30,000 A						3 V AC				100 mV/A 10 mV/A 1 mV/A 0,1 mV/A				10 Hz .. 5 kHz 10 Hz .. 20 kHz 10 Hz .. 20 kHz 10 Hz .. 20 kHz	≤ 1%	P01120632
	A130 30-300-3000/3 (80 cm / Ø 25 cm)	0.5 A .. 30 A 0.5 A .. 300 A 0.5 A .. 3,000 A						3 V AC				100 mV/A 10 mV/A 1 mV/A				10 Hz .. 20 kHz 10 Hz .. 20 kHz 10 Hz .. 20 kHz	≤ 1%	P01120633

MiniFlex® flexible probes for AC current

MA110, MA130

600 V CAT IV	1000 V CAT III	80 mA	3000 A _{AC}	4 calibres	IP 67
-----------------	-------------------	-------	----------------------	---------------	----------



MA200

600 V CAT IV	1000 V CAT III	1 MHz
-----------------	-------------------	-------



MA110 model

Measurement from 20 mA.
Can be connected to the AC voltage input (mVAC / VAC) of any multimeter or measuring instrument equipped with Ø 4 mm female banana plugs.

Three-phase MA130 model

Can be connected to the AC voltage inputs (mVAC / VAC) of any power analyser, logger or measuring instrument equipped with BNC plugs.

MA200 model

Equipped with a BNC output and can be connected to all types of oscilloscopes. Offers high bandwidth.

Series	Model	Input Measurement range				Output - Connections			Specific features					Reference				
		Very low current	Low current	Medium current	High current	Altering current	Direct current	Current	Voltage	Lead + safety plugs ø 4 mm	Female sockets ø 4 mm	BNC connector (coaxial)	Transformation ratio (input/output)		Output protected against overvoltages	Automatic DC zero	Power measurement (low phase shift)	Bandwidth (frequency in Hz)
	MA110 3-30-300-3000/3 (17 cm / Ø 4.5 cm)		0.08 A .. 3 A 0.5 A .. 30 A 0.5 A .. 300 A 0.5 A .. 3,000 A					3 VAC				1 V/A 100 mV/A 10 mV/A 1 mV/A				10 Hz .. 10 kHz 10 Hz .. 20 kHz 10 Hz .. 20 kHz 10 Hz .. 20 kHz	≤ 1%	P01120660
	MA110 3-30-300-3000/3 (25 cm / Ø 7 cm)		0.08 A .. 3 A 0.5 A .. 30 A 0.5 A .. 300 A 0.5 A .. 3,000 A					3 VAC				1 V/A 100 mV/A 10 mV/A 1 mV/A				10 Hz .. 10 kHz 10 Hz .. 20 kHz 10 Hz .. 20 kHz 10 Hz .. 20 kHz	≤ 1%	P01120661
	MA110 3-30-300-3000/3 (35 cm / Ø 10 cm)		0.08 A .. 3 A 0.5 A .. 30 A 0.5 A .. 300 A 0.5 A .. 3,000 A					3 VAC				1 V/A 100 mV/A 10 mV/A 1 mV/A				10 Hz .. 10 kHz 10 Hz .. 20 kHz 10 Hz .. 20 kHz 10 Hz .. 20 kHz	≤ 1%	P01120662
	MA130 30-300-3000/3 (25 cm / Ø 7 cm)		0.5 A .. 30 A 0.5 A .. 300 A 0.5 A .. 3,000 A					3 VAC				100 mV/A 10 mV/A 1 mV/A				10 Hz .. 20 kHz 10 Hz .. 20 kHz 10 Hz .. 20 kHz	≤ 1%	P01120663
	MA200 30-300/3 (17 cm / Ø 4.5 cm)		0.5 A...45 A _{PEAK} 0.5 A...450 A _{PEAK}					4,5 V _{PEAK}				100 mV/A 10 mV/A					≤ 1% + 0.3 A	P01120570
	MA200 30-300/3 (25 cm / Ø 7 cm)		0.5 A...45 A _{PEAK} 0.5 A...450 A _{PEAK}					4,5 V _{PEAK}				100 mV/A 10 mV/A				5 Hz...1 MHz	≤ 1% + 0.3 A	P01120571
	MA200 3000 /3 (35 cm / Ø 10 cm)		5 A...4,500 A _{PEAK}					4,5 V _{PEAK}				1 mV/A					≤ 1% + 0.3 A	P01120572

Power quality & installation supervision

Functions

- > Configuration of all the functions of instruments connected to a PC or via Bluetooth
- > Recovery of the recorded measurement data
- > Backup of measurement files
- > Opening of saved files
- > Processing and creation of reports (EN50160)
- > Export into an Excel spreadsheet
- > Export in .pdf format
- > Database management

Additional info

The DataView® software

- > Automatically recognizes the instrument connected when it is connected to the PC and opens the corresponding menu. Users then have direct access to the configuration and to the saved data
- > Includes a large number of predefined report templates for quick generation in compliance with the applicable standards. Users can create their own models to fit their needs and add their own comments directly



Scan this code to find out more about DataView's performance features

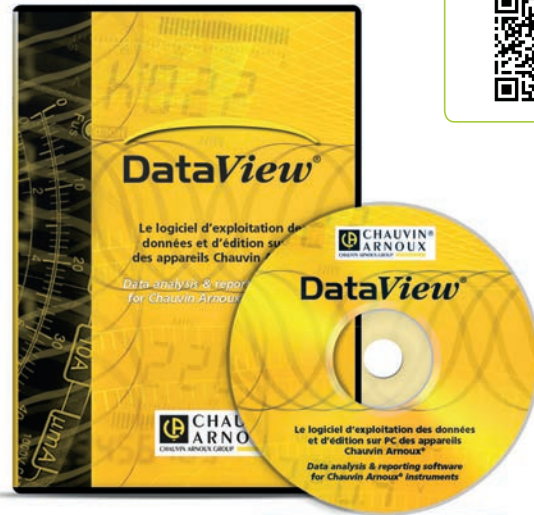

Reference	P01102095
-----------	-----------



TEST AND MEASUREMENT ACCESSORIES

Selection of Chauvin Arnoux accessories

- > Ø 4 mm banana connection accessories
- > Temperature measurement
- > Electrical installation testing
- > Protection, storage and transport

Scan this code to find out more about the selection of Chauvin Arnoux accessories



... by function

A

Accessories:	
• Ø 4 mm banana connections	p.38
• transport (soft cases, hard cases, bags)	p.38
• protection (soft cases, hard cases, bags)	p.38
AC current miniclamps	p.38
AmpFlex®	p.29
AmpFlex® clamps	p.29
ASYC IV digital multimeters	p.08
C	
Cable locator	p.25
Clamp meters:	
• AC current clamps	p.29-30
• AC/DC current clamps	p.25-31
• digital clamp multimeters	p.04-05
• earth/ground clamps and loop tester	p.24
CO ₂ / Temperature / Humidity measurement	p.12
Conductivity meter	p.14
Contact thermometers	p.11

D

DataView® software	p.42
Digital ammeters with flexible sensor	p.40
Digital insulation testers	p.20-21
Digital tester	p.10

E

Earth and resistivity kit	p.27
Earth/ground and resistivity testers	p.26
Earth/ground and resistivity testers with adapter for pylon earth measurements	p.27
Earth/ground testers	p.19
Electrical power analysers for three-phase networks	p.32-33

F

Flexible current sensors	p.40-41
--------------------------	---------

I

Installation testers	p.16-17
Insulation and continuity testers	p.18-19

L

Luxmeters	p.13
-----------	------

M

Megohmmeters (see Insulation testers)	
Micro-ohmmeters	p.30

O

On-site digital oscilloscopes	p.36-37
-------------------------------	---------

P

pH-meter	p.15
pH-tester	p.14
Power Analyser Transfer software	p.33
Power and energy loggers	p.34

R

Ratiometer	p.31
Reeling box	p.33

T

Testers	p.10
Thermal cameras	p.16-17
Thermo-anemometers	p.13
Thermo-hygrometers	p.12
TRMS digital multimeters	p.06

V

Voltage detector	p.10
------------------	------

... by product

A

A110/130	Flexible current sensors	p.40
A193-450/A193-800	AmpFlex® clamp meters	p.34
A196	AmpFlex® clamp meters	p.34
AmpFlex®	Flexible current sensors	p.40

B

Banana connection accessories Ø 4 mm	p.42
--------------------------------------	------

C

C100 to C173 AC	AC current clamps	p.38
C193	AC current clamp	p.34
CA 1110	Luxmeters	p.13
CA 1227	Thermo-anemometers	p.13
CA 1246	Thermo-hygrometers	p.12
CA 1510	CO ₂ - Temperature - Humidity logger	p.12
CA 1821/1822/1823	Logger contact thermometers	p.11
CA 1950/1954	Thermal camera	p.16-17
CA 1821/1822/1823	Logger contact thermometers	p.11
CA 1950/1954	Thermal camera	p.16-17
CA 5273/5275/5277	TRMS multimeters	p.08
CA 6011	Installation tester	p.18
CA 6116N/6117/6133	Installation testers	p.20-21
CA 6240/6250	Micro-ohmmeters	p.26
CA 6292	Micro-ohmmeters	p.30
CA 6416/6417	Earth clamp meters and loop testers	p.28
CA 6422/6424	Earth/ground tester	p.19
CA 6460/6462/6470N/6471	Earth/ground and resistivity testers	p.26
CA 6472/6474	Earth/ground and resistivity testers with adapter for pylon earth measurement	p.27
CA 6505	Digital insulation tester	p.21
CA 6522/6524/6526/6532/6534/6536	Insulation and continuity testers	p.22-23
CA 6528	Insulation tester	p.18
CA 6541/6543/6545/6547/6549	Digital insulation testers	p.24
CA 6550/6555	Digital insulation testers	p.25
CA 6681	Cable locator	p.29
CA 757	Digital tester	p.10
CA 773	Voltage Absence Tester	p.10
CA 8331/8333/8336/8436	Electrical power analysers for three-phase networks	p.32-33
CA 10001	pH tester	p.14
CA 10101	pH-meter	p.15
CA 10141	Conductivity meter	p.14

D

DataView®	software	p.38
D30CN / D36N	AC current clamps	p.34
D38N	AC current clamp	p.34
DTR 8510	Single-phase ratiometer	p.31

E

Earth/ground and resistivity kit	p.27	
E3N	AC/DC current clamp	p.34

F

F201/203/205	Digital clamp multimeters	p.04-05
F401/403/405/F407	Digital clamp multimeters	p.04-05
F603/605/F607	Digital clamp multimeters	p.04-05

J

J93	AC/DC current clamp	p.34
-----	---------------------	------

K

K1/K2	AC/DC current clamps	p.38
-------	----------------------	------

M

MA 100	Flexible current sensors	p.37
MA193	AC current clamps	p.29-30
MA 200	Flexible current sensors	p.39
MA400D/MA4000D	Flexible current sensors	p.36
MINI 01/02/03/05/09/102/103	AC current clamps	p.38
MN60	AC current clamp	p.39
MN 08 to MN 89	AC current clamps	p.38
MN93/93A	AC current clamps	p.34
MTX 203/204	TRMS digital multimeters	p.06
MTX 3290/3291/3292/3293	Digital multimeters	p.07

O

OX 5022/5042	On-site digital oscilloscopes	p.36
OX 9302-BUS/9062/9102/9104/9304	On-site oscilloscopes	p.37

P

PAC15/16/17/25/26/27	AC/DC current clamps	p.39
PAC93	AC/DC current clamps	p.34
PEL 102/103/105	Power and energy loggers	p.34
Power Analyser Transfer	Software	p.33

R

Reeling Box	Cable reeler	p.29
-------------	--------------	------

Y

Y1N	AC current clamp	p.34
Y7N	AC current clamp	p.35



CA 6528 digital insulation tester



CA 6011 installation tester

NEW



CA 6422 & CA 6424 2P & 3P earth/ground testers



906 161 100 - Ed.14 - 2020 - Non-contractual document. Photos : Chauvin Arnoux Group. Please confirm specifications when ordering.



Chauvin Arnoux International

190, rue Championnet
75876 Paris Cedex 18
export@chauvin-arnoux.fr
www.chauvin-arnoux.com
tel : +33 1 44 85 44 38
fax : +33 1 46 27 95 59