



Micro Detectors

Italian Sensors Technology



Fork Sensors catalogue





Products

FC
forks





Fork sensors

Photoelectric fork sensors for object detection

- FC5 p.6
- FC6 p.12

Photoelectric fork sensors for labelling detection

- FC7 p.18

Ultrasonic fork sensors for labelling detection

- FC8 p.24













Products

FC
forks

Photoelectric Sensors

Forks

		FC5 	FC6I 	FC6L 	FC7 
slot sensor for object detection		•	•	•	—
slot sensor for labelling		—	—	—	•
sensing distance		50, 80, 120 mm	30, 50, 80, 120 mm	30, 50, 80, 120 mm	3 mm
slot depth detection		60, 124 mm	42, 59 mm	42, 59 mm	42 mm
minimum size of object detected		0,8 mm	0,2 mm	0,05 mm	2x2 mm
emission		red LED	infrared LED	LASER (class 1) 470 nm	infrared LED
switching frequency		4 kHz	10 kHz	10 kHz	10 kHz
supply voltage	Vcc	•	•	•	•
	Vac	—	—	—	—
output type	NPN - NO	•	—	—	—
	NPN - NC	•	—	—	—
	PNP - NO	•	—	—	—
	PNP - NC	•	—	—	—
	NPN - NO / NC	—	—	—	•
	PNP - NO / NC	—	—	—	•
	NPN/PNP - NO/NC	—	•	•	—
	SCR	—	—	—	—
temperature range		-10...+60 °C	-20...+60 °C	-20...+50 °C	-20...+60 °C
protection degree		IP67	IP65	IP65	IP65
housing material		painted aluminium	painted aluminium	painted aluminium	termoplastic (PA12)
head material		—	—	—	—
output	cable	—	—	—	—
	M12 plug	M8 3 pin	M8 4 pin	M8 4 pin	M8 4 pin
ATEX		—	—	—	—
other certifications		 	 US LISTED 	 PENDING  US LISTED 	 



Ultrasonic Sensors

Forks

FC8

New series



nominal sensing distance sn		3 mm
slot depth detection		69 mm
minimum length of label		2 mm
minimum distance between 2 labels		2 mm
emission		ultrasonic
ultrasonic		•
switching frequency		1,5 kHz
supply voltage	Vcc	•
	Vac	—
output type	NPN - NO	—
	NPN - NC	—
	PNP - NO	—
	PNP - NC	—
	NPN - NO / NC	•
	PNP - NO / NC	•
	NPN/PNP - NO/NC	—
temperature range		+5...+55 °C
protection degree		IP65
housing material		painted aluminium
output	M8 3 pins	—
	M8 4 pins	•
ATEX		—
other certifications		



Products

FC5
fork



Series **FC5**

Fork



www.microdetectors.com

Industries and applications

Production processes

Packaging lines

Beverage industry



Main Features

Plug and Play without adjustment

High power RED LED emission

Minimum size object detection 0,8 mm

Metal housing

LED Indicator high Visibility

Switching frequency 4 KHz

-10...+60 °C operating temperature range

3 wires: PNP or NPN, Lo/Do

M8 connectors 3pins

Certifications



Protection degree

IP67





Products

FC5
fork



FC5 optical fork

FC5 forks have a metallic body and do not have an adjusting system. Thanks to their simplicity, the installation and functioning are fast and easy. The output state is all-around-visible thanks to the orange led, fitted on the rear side of the sensor.

There is a wide range of 3 wires models: NPN or PNP, LightON or DarkON, forks from 50 mm up to 124 mm large and from 60 mm up to 120 mm wide, covering a wide range of applications.

FC5 forks have a IP67 certification degree and are available with M8 3 pins connector.

Pack content

Further commercial and technical documents available

High resolution pictures

Customization already tested

-

Minimum quantity that can be ordered

1 pcs

FC5 R / D P - 05 06 - 1 F

FC5 Fork detection for objects**R** LED red emission**D** Dark ON**L** Light ON**P** PNP digital output**N** NPN digital output**05** Width slit detection 50 mm**08** Width slit detection 80 mm**12** Width slit detection 120 mm**06** Depth slit detection 60 mm**12** Depth slit detection 124 mm**1** Metal housing - aluminium**F** Plug M8 3 pin

Available models

supply	installation	width	depth	NPN Lo	PNP Lo	NPN Do	PNP Do
12 ... 24 Vcc	M8 3 pins	50 mm	60 mm	FC5R/LN-0506-1F	FC5R/LP-0506-1F	FC5R/DN-0506-1F	FC5R/DP-0506-1F
		80 mm	60 mm	FC5R/LN-0806-1F	FC5R/LP-0806-1F	FC5R/DN-0806-1F	FC5R/DP-0806-1F
		120 mm	124 mm	FC5R/LN-1212-1F	FC5R/LP-1212-1F	FC5R/DN-1212-1F	FC5R/DP-1212-1F



Products

FC5
fork

Specifications

according to IEC EN 60947-5-2

	
models	FC5R/**_**_**
nominal sensing distance sn	50...120 mm
minimum size of object detected	0.8 mm
emission	red LED, modulation of light
interference to external light	10.000 lux (5.000 lux incandescent lamp)
rated operational voltage ue	12 ... 24 Vdc (with protection against reverse polarity)
max ripple content	10%
no-load supply current	<20 mA
load current	100 mA
output voltage drop	< 1.5 V @ IL=100 mA
switching frequency	4.000 Hz
supply electrical protections	Inverse-polarity protected. Short-circuit output protected. Interference suppression.
operation temperature range	- 10 ...+ 60 °C
storage temperature	- 40 ...+ 80 °C
protection degree	IP67 (EN60529)
time delay before availability	150 ms max
housing material	Painted aluminium and polyamide/glass
plug	M8 3 pins
weight approx.	80 g to 190 g

- BN brown
- BU blue
- BK black
- WH white

Electric diagrams of the connections

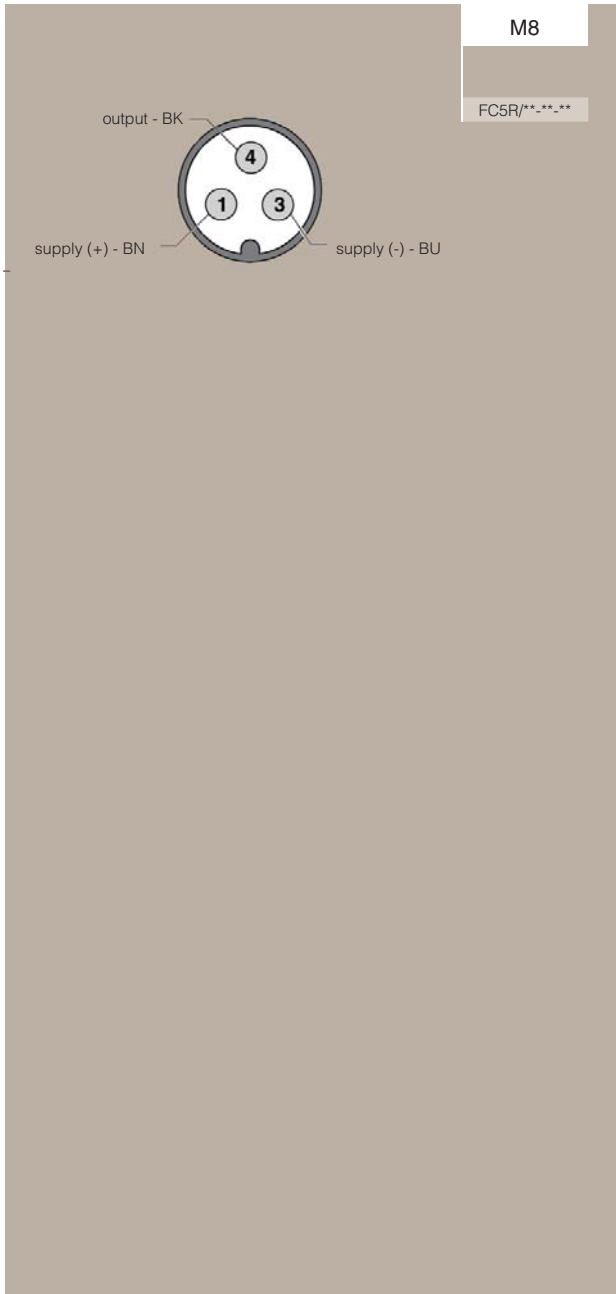

NPN output

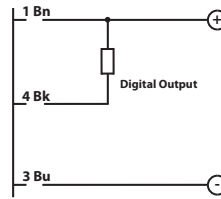

PNP output

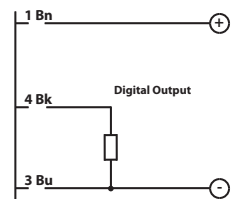

Dimensions

FC5R/**-**-**

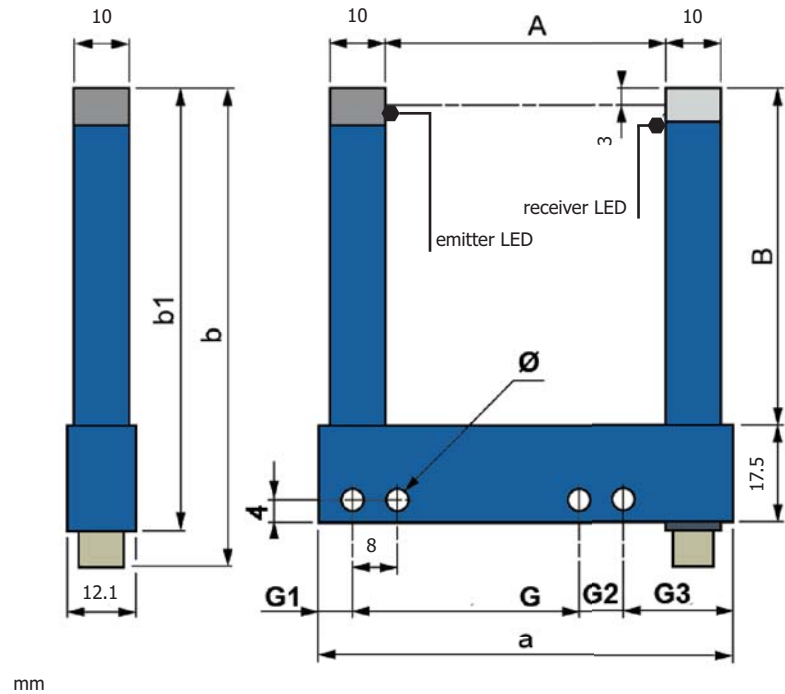

models	width slit detection	depth slit detection	a	b	b1	G	G1	G2	G3	Ø
FC5R/**-0506-1F	50	60	74	85.7	77.5	40	6.5	19.5	4 x 4.3	4 x 4.3
FC5R/**-0806-1F	80	60	104	85.7	77.5	70	6.5	19.5	4 x 4.3	4 x 4.3
FC5R/**-1212-1F	120	124.3	144	150.2	142	100	17	17	4 x 4.3	4 x 4.3



Products

FC6
fork



Series **FC6**

Fork



www.microdetectors.com

Industries and applications

Detection of small pieces, objects, holes, and marks
Positioning Robotic Arms
Control of micro assembly
Edge Detection



Main features

Simple and accurate adjustment manually by +/- buttons

Infrared emission

LASER emission class 1

Metal housing

Light/Dark switching, selectable by button

Minimum size object detection 0,2 mm (FC6I) and 0,05 mm (FC6L)

Switching frequency 10KHz

M8 connectors (4pins): PNP/NPN, Lo/Do

-20...+60 °C operating temperature range

Certifications



(only for FC6I)

Protection degree

IP65





Products

FC6
fork



FC6 optical fork with regulation system

FC6 optical forks have a metal housing.

Thanks to their high switching frequency (10kHz) can be used in high speed applications.

They are available both with infrared light emission (FC6I) and with class 1 LASER emission (FC6L).

The high resolution (FC6I up to 0,2mm and FC6L up to 0,05 mm) allows to detect small objects or objects placed in closer installation areas.

Easy and fast mounting.

Simple and accurate adjustment by +/- buttons.

Bipolar output (NPN and PNP), LightON and DarkON modes configurable by button.

Wide models range: Forks from 30 mm up to 120 mm wide and from 42 mm up to 60 mm depth.

Available also with M8 4 pins connector.

Pack content

Installation manual (English + Italian): CAT8BFC1362401

Further commercial and technical documents available

High resolution pictures

Customization already tested

-

Minimum quantity that can be ordered

1 pcs

Code description

FC6 L / 0 B - 03 04 - 1 F

- FC6** Fork for objects
- L** LASER emission (470 nm)
- I** LED Infrared emission
- 0** State (Lo/Do) selectable
- B** Digital output (NPN/PNP)
- 03** Width slit detection 30 mm
- 05** Width slit detection 50 mm
- 08** Width slit detection 80 mm
- 12** Width slit detection 120 mm
- 04** Depth slit detection 42 mm
- 06** Depth slit detection 59 mm
- 1** Metal housing - Aluminum
- F** Plug M8 4 pin

Available models

supply	installation	width	depth	FC6I, NPN - PNP, Lo/Do selectable	FC6L, NPN - PNP, Lo/Do selectable
12 ... 24 Vdc	M8 - 4 Pins	30 mm	42 mm	FC6I/0B-0304-1F	FC6L/0B-0304-1F
		50 mm	59 mm	FC6I/0B-0506-1F	FC6L/0B-0506-1F
		80 mm	59 mm	FC6I/0B-0806-1F	FC6L/0B-0806-1F
		120 mm	59 mm	FC6I/0B-1206-1F	FC6L/0B-1206-1F



Products

FC6
fork

Specifications

according to IEC EN 60947-5-2

		
models	FC6L/**_**_**	FC6I/**_**_**
nominal sensing distance sn	30...120 mm	
minimum size of object detected	0.05 mm	0.2 mm
emission	red laser 670 nm, modulated, class 1	infrared LED, modulated
interference to external light	10.000 lux (5.000 lux incandescent lamp)	
rated operational voltage ue	12 ... 24 Vdc (with protection against reverse polarity)	
max ripple content	10%	
no-load supply current	40 mA	
load current	100 mA	
output voltage drop	< 2 V @ IL=100 mA	
switching frequency	10 KHz	
supply electrical protections	Inverse-polarity protected. Short-circuit output protected	
operation temperature range	- 20 ...+ 50 °C	- 20 ...+ 60 °C
storage temperature	- 30 ...+ 80° C	
protection degree	IP65 (EN60529)	
housing material	Painted aluminium and polyamide/glass	
plug	M8 4 pins	
weight approx.	55 g to 128 g	

- BN brown
- BU blue
- BK black
- WH white

Electric diagrams of the connections

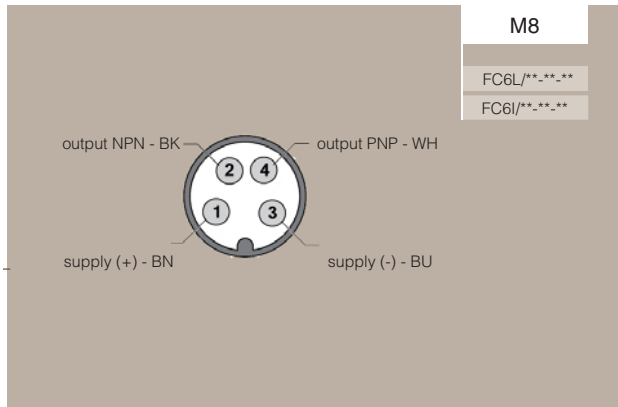

PNP/NPN selectable output

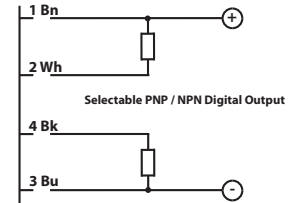

Dimensions

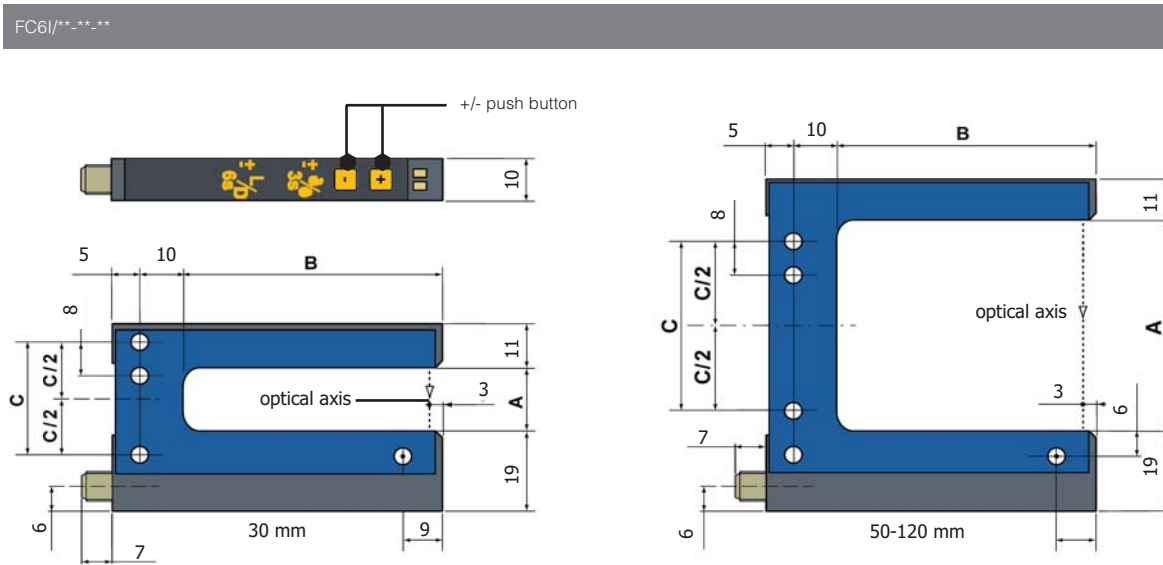
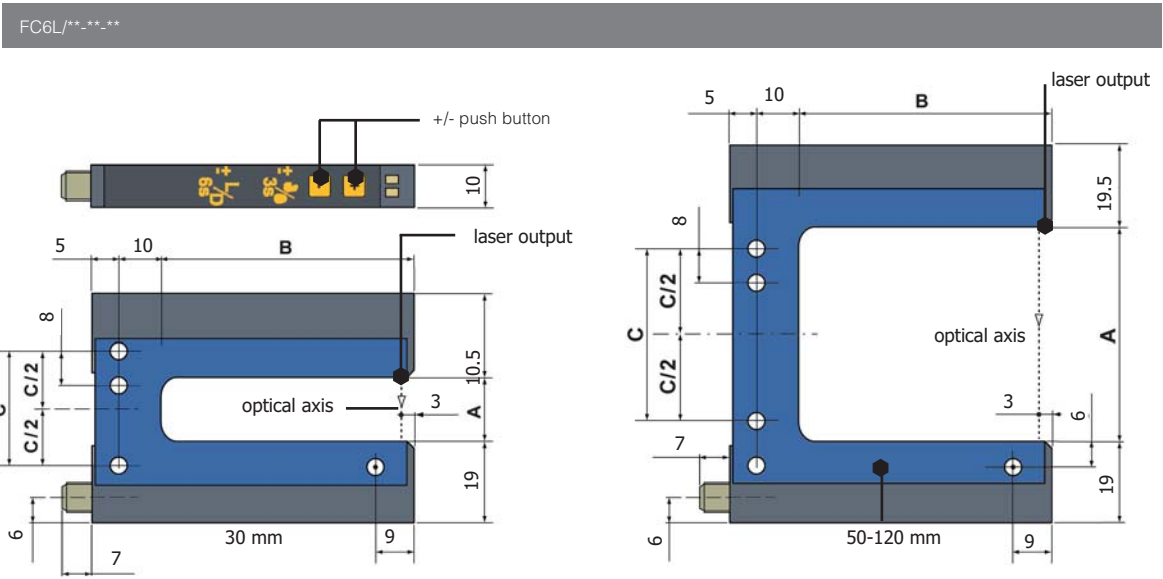

Width slit detection: 30 - 120 mm

code	A mm	B mm	C mm
FC6*/**-03*-**	30	42	42
FC6*/**-05*-**	50	59	40
FC6*/**-08*-**	80	59	70
FC6*/**-12*-**	120	59	110



Products

FC7
fork

Series FC7

Fork



www.microdetectors.com

Industries and applications

label recognition
labels counting and positioning
double sheet detection
band-aids detection





Main Features

Dynamic Teach-in or control panel and manual adjustment with “+/-” buttons

Minimum object detection 2 mm (gap between labels), 2 mm (label size)

Infrared emission

Light/Dark switching, selectable by button

Switching frequency 10 kHz

PA housing

M8 connectors (4 pins): PNP or NPN, Lo/Do selectable

-20 ...+60 °C operating temperature range

Certifications



Protection degree

IP65





Products

FC7
fork



FC7 optical fork for labels

FC7 forks have a very strong thermoplastic housing. Thanks to its thin form and its design, it has been thought for the labeling process.

Its high switching frequency (10 kHz) and low response time allow to detect fast moving labels with high repeatability precision.

Infrared light emission.

Simple and accurate adjustment by +/- buttons.

The adjustment can be made during the label strip processing.

The NPN or PNP output, Light ON and Dark ON modes are configurable through a push-button, the forth wire is the remote Teach-in.

Available with M8 4 pins connector.

IP65 protection degree.

Pack content

Installation manual (English + Italian): CAT8BFC1362301

Further commercial and technical documents available

High resolution pictures

Customization already tested

-

Minimum quantity that can be ordered

1 pcs

Code description

FC7 I / 0 P - M3 04 - 0 F

FC7 Fork for labels

I LED Infrared emission

0 Lo/Do output selectable, remote teach

P PNP digital output

N NPN digital output

M3 Width slit detection 3 mm

04 Depth slit detection 42 mm

0 Thermoplastic case

F M8 plug 4 pin

Available models

supply	installation	PNP	NPN
12 ... 24 Vdc	M8 - 4 Pins	FC7I/0P-M304-0F	FC7I/0N-M304-0F



Products

FC7
fork

Specifications

according to IEC EN 60947-5-2



models	FC7I/**_**_**
nominal sensing distance sn	3 mm
minimum lenght of label	2 mm
minimum distance between 2 labels	2 mm
slot depth detection	42 mm
slot width detection	3 mm
emission	infrared
maximum flow rate	200 m/min
detection accuracy	+/- 50 um at 150 m/min
rated operational voltage ue	12 ... 24 Vdc (with protection against reverse polarity)
max ripple content	10%
no-load supply current	35 mA
load current	100 mA
output voltage drop	< 2 V @ IL=100 mA
switching frequency	10 KHz
time delay before availability	50 us max
supply electrical protections	Polarity reversal, transient
operation temperature range	- 20 ...+ 60 °C
storage temperature	- 30 ...+ 80 °C
protection degree	IP65, IEC (EN60529)
housing material	PA
plug	M8 4 pins
weight approx.	35 g

- BN brown
- BU blue
- BK black
- WH white

Electric diagrams of the connections

M8

FC7I/**-**-**

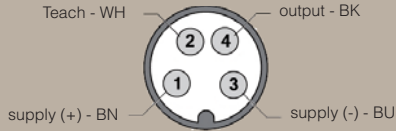

PNP output

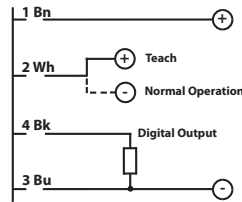

NPN output

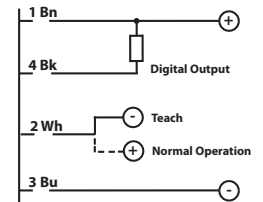

Dimensions

FC7I/**-**-**

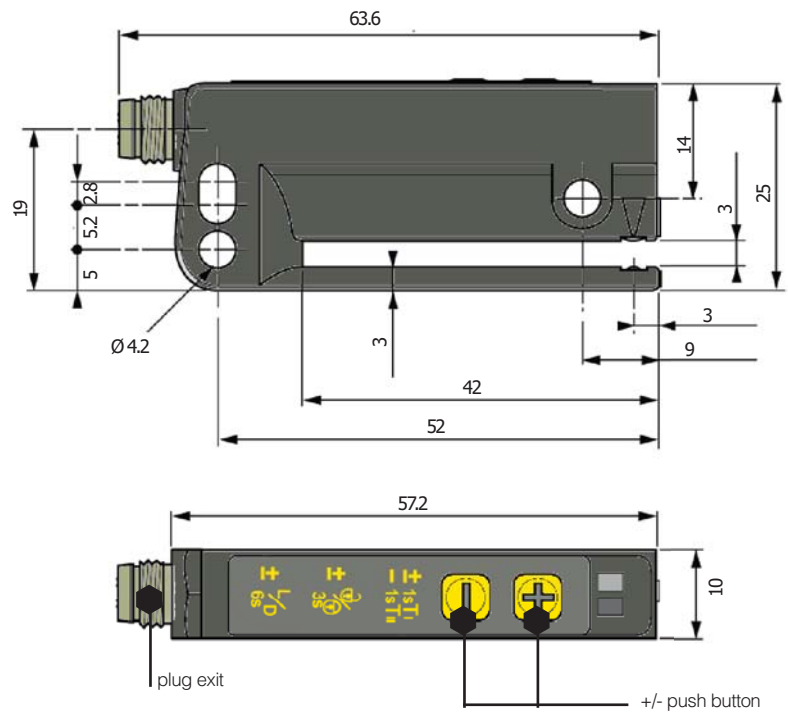

mm



Products

FC8
fork



Series **FC8**

Fork



www.microdetectors.com

Industries and applications

Detection of double labels, or labels either on transparent strip or coloured one
Packaging
Labelling machine
Paper and Printing Machine



Main Features

Ultrasonic fork sensor for transparent labels, any opaque material with connector M8 4-pole
Teach-in models with dynamic and remote teach
Ultrasonic technology
Small size easy to locate
NPN and PNP, Lo/Do total configurable
Width slit detection 3 mm
Depth slit detection 69 mm
Maximum switching frequency 1.500 Hz
Aluminum case

Certifications



Protection degree

IP65





Products

FC8
fork



FC8 ultrasonic fork for labels

FC8 forks have a strong aluminium housing. Thanks to its thin form and its design, it has been thought for the labeling process.

Its high switching frequency (1500 Hz) and low response time allow to detect labels placed at 2 mm distance

Simple and accurate adjustment by +/- buttons.

Through the ultrasonic technology it is possible to detect any kind of labels, included the transparent ones positioned on transparent base or on coloured pictures support.

Accurate adjustment possible through the push button +/-, and the remote teach in.

The NPN or PNP output, Light ON and Dark ON modes are configurable through a push-button, the fourth wire is the remote Teach-in.

Available with M8 4 pins connector.

IP65 protection degree

Pack Content

Installation manual (English + Italian): CAT8BFC1362201

Further commercial and technical documents available

High resolution pictures

Customization already tested

-

Minimum quantity that can be ordered

1 pcs

Code description

FC8 U / 0 P - M3 07 - 1 F

FC8 Ultrasonic fork for labels

U Ultrasonic

0 Lo/Do output selectable, remote teach

P PNP digital output

N NPN digital output

M3 Width slit detection 3 mm

07 Depth slit detection 69 mm

1 Metal housing - aluminium

F M8 plug 4 pin

Available models

supply	installation	PNP	NPN
12 ... 24 Vdc	M8 - 4 Pins	FC8U/0P-M307-1F	FC8U/0N-M307-1F



Products

FC8
fork

Specifications

according to IEC EN 60947-5-2



models	FC8U/0*-M307-1F
nominal sensing distance sn	3 mm
minimum length of label	2 mm
minimum distance between 2 labels	2 mm
slot depth detection	69 mm
slot length detection	-
emission	ultrasonic
maximum flow rate	180 m/min
detection accuracy	+/- 0.20 mm at 120 m/min
rated operational voltage ue	12 ... 24 Vdc (with protection against reverse polarity)
max ripple content	10%
no-load supply current	45 mA
load current	100 mA
output voltage drop	< 2 V @ IL=100 mA
switching frequency	1,500 Hz
time delay before availability	300 us
supply electrical protections	Short-circuit output protected Interference suppression
operation temperature range	+ 5 ...+55 °C
storage temperature	- 20 ...+70 °C
protection degree	IP65 (EN60529)
housing material	painting aluminium
plug	M8 4 pins
weight approx.	130 g

- BN brown
- BU blue
- BK black
- WH white

Electric diagrams of the connections

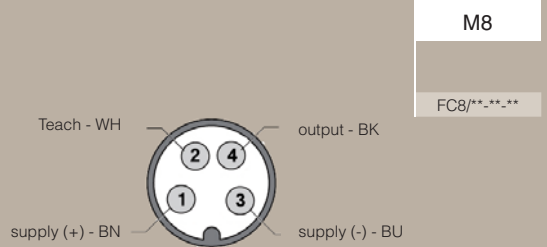

PNP output NPN output

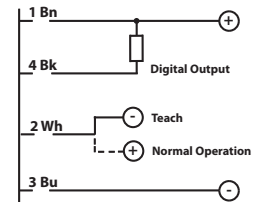
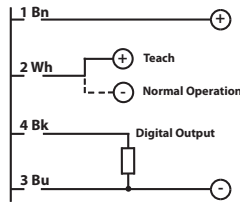

dimensions

FC8U/**_**_**_**

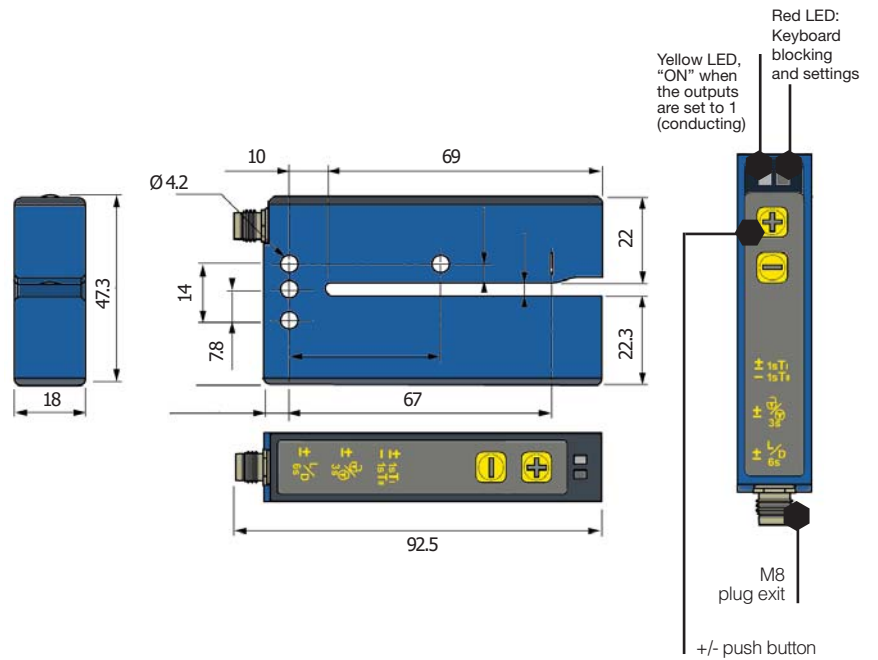

mm



Forks
Catalogue



CAT3EFC1372801 FORK SENSORS CATALOGUE ENGLISH ED.01/2013

All information written in this catalogue are subject to modifications without notice.
They don't represent any obligation for M.D. Micro Detectors

Any variation will be implemented in this catalogue and its electronic version, available on the corresponding page of M.D. Micro Detectors website:
www.microdetectors.com